

FN41V3

**AMD Athlon XP/Athlon/Duron
462-pin Processor
with 200/266/333/400 MHz FSB
Based DDR MAINBOARD**

User's Manual

Shuttle® FN41V3

AMD Athlon XP/Athlon/Duron 462-pin Processor with 200/266/333/400 MHz FSB Based DDR Mainboard Manual Version 1.0

Copyright

Copyright© 2004 by Shuttle® Inc. All Rights Reserved.

This publication, including all photos, illustrations, and software, is protected under international copyright laws, with all rights reserved. Reproducing any of the material contained herein is prohibited without the consent of the publisher.

Disclaimer

Shuttle® Inc. shall not be liable for any incidental or consequential damages resulting from the performance or use of this product.

This company makes no representations or warranties regarding the contents of this manual. Information in this manual has been carefully checked for reliability; however, no guarantee is given as to the correctness of the contents. In the interest of continued product improvement, this company reserves the right to revise the manual or include changes in the specifications of the product described within it at any time without notice and without obligation to notify any person of such revision or changes. The information contained in this manual is provided for general use by the customers.

Trademarks

Shuttle is a registered trademark of Shuttle Inc.

NVIDIA is a registered trademark of NVIDIA Corporation.

AMD, Athlon and Duron are registered trademarks of AMD Corporation.

PS/2 is a registered trademark of IBM Corporation.

AWARD is a registered trademark of Award Software Inc.

Microsoft and Windows are registered trademarks of Microsoft Corporation.

General Notice: Other product names used in this manual are ascribed to their respective owners and acknowledged.

WARNING

Thermal issue is highly essential for processors with a speed of 600MHz and above. Hence, we recommend you to use the CPU fan qualified by AMD or motherboard manufacturer. Meanwhile, please make sure CPU and fan are securely fastened well. Otherwise, improper fan installation not only gets system unstable but also could damage both CPU and motherboard because insufficient thermal dissipation.

If you would like to know more about thermal topic please see **AMD website** for detailed thermal requirement through the address:

<http://www.amd.com>

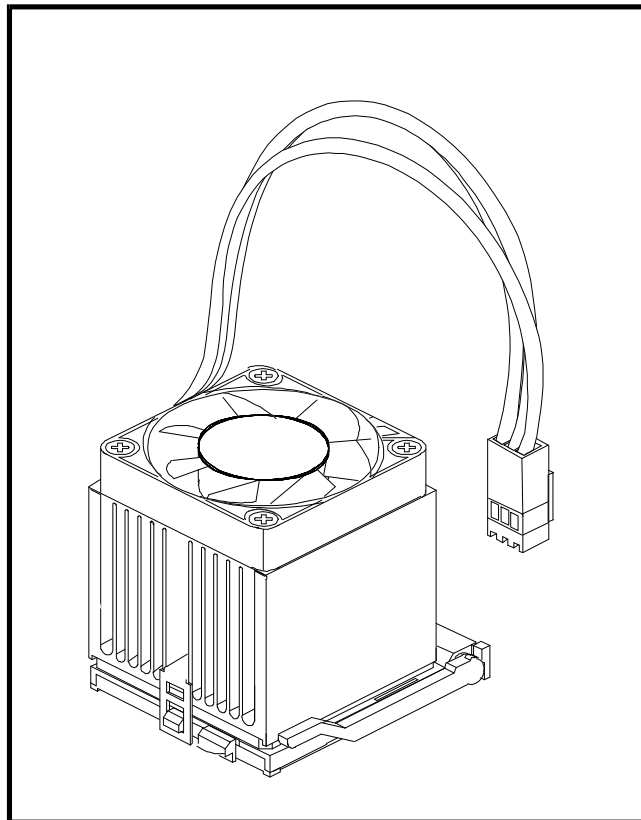

NOTICE

If you've changed your CPU or overclocked your system, the system may fail to boot up, even with a Clear CMOS jumper physically resetted. The reason is that NVIDIA's new nForce2 chipset introduces a way to reset a Clear CMOS jumper without removing a chassis. Please follow the steps listed below:

1. Turn off your computer and unplug the power cable. Reconnect it after 30 seconds;
2. Press <Insert > and then press your computer's start button. Continue holding <Insert> until the system begins the POST (Power-On Self Test);
3. Immediately press to enter the BIOS;
4. Select 'Load Optimized Defaults' to return your system to a bootable condition; then select 'SAVE to CMOS and EXIT';
5. Reboot your system.

Moreover, if your system fails to boot up after you reset the CPU FSB, select "SAVE to CMOS and EXIT" in the BIOS. After the system restarts, there is on screen a message warning you not to reset or turn off your computer:

**Warning! New setting is updating now
Do not Reset or Shutdown the system**

Your system works after the BIOS is updated.

Statement of Shuttle Mainboard via the EMI Test

Shuttle mainboards have been via the EMI test in terms of series of regulations: EN55022/ CISPR22/AS/NZS3548 Class B, EN55024 (1998/AS/NZS), EN4252.1 (1994), EN61000, ANSI C63.4 (1992), CFR47 Part 15 Subpart B, and CNS13438 (1997). The items tested are illustrated as follows:

(A) Voltage: AC 110V/60HZ & AC 230V/50HZ

(B) Tested Product Information:

Product Name: PC Mainboard

Status: Sample

Model Name: FN41V3

S/N: N/A

CPU:

External Frequency: 200 MHz

AMD Athlon XP 3000+, 3200+

External Frequency: 166 MHz

AMD Athlon XP 2800+/3000+

External Frequency: 133 MHz

AMD Athlon XP 2200+/2400+/2600+

VGA Port: two port with 15 pins

Serial Port: one port with 9 pins

S-Video Port: one port with 7 pins

IEEE1394a Port: two ports with 6 pins respectively

LAN Port: one port with 8 pins (10Mbps/100Mbps)

USB 2.0 Port: two ports with 4 pins respectively

Mouse Port: one port with 6 pins

Keyboard Port: one port with 6 pins

Center/Bass-Out & Rear-Out & Mic-In Ports: one port for each

DIMM Memory (optional): DDR 400 256 MB *2

Power Cable: Detachable and Shielded (with a GND pin)

Monitor: CRT

Maximum Resolution: 1280 X 1024 V:60Hz

All CPUs have completely been tested, and values offered by the worst EMI combination of CPU external frequency are listed as follows:

Test Mode	External Frequency	CPU	Case Open/Closed
1	200 MHz	Athlon XP 3200+	Closed
2	200 MHz	Athlon XP 3200+	Open
3	166 MHz	Athlon XP 3000+	Closed
4	166 MHz	Athlon XP 3000+	Open
5	133 MHz	Athlon XP 2600+	Closed
6	133 MHz	Athlon XP 2600+	Open

(C) Remedy for the Tested Product & Its EMI Interference:

Remedy: N/A

EMI Interference:

Crystal: 24.576 MHz (Y7)/ 24.576 MHz (Y5)/12 MHz (Y4)/ 14.318 MHz(Y3) /
25 MHz (Y6) / 27 MHz (Y8)

Clock Generator: N/A

(D) Supported Host Peripherals:

Host Peripheral	Product Name	Model Name	S/N	FCC ID
#1	Case	SN41G2	N/A	
#2	Power Supply (switchable)	AM630BS20S		
#3	Western Digital HDD (30 GB)	WD300BB		3902B934
#4	MITSUMI FDD	D353M3D		62007003
#5	Panasonic CD-ROM Player	DVD-115		3892A807

(E) Notices for Assembling Computers:

1. Cases should be made of iron or other metal that has good electric conductivity.
2. Cylinders in a case should be made of metal, and as having a mainboard mounted in a case, make sure screws are all utilized and fastened on a mainboard.
3. An I/O shielding should be contacted with I/O metallic parts of a mainboard.
4. Cables should appropriately be arranged and fixed in a case. Follow instructions:
 - Leave IDE cables not crossed upon CPU and SDRAM;
 - Leave power cables minimum in length, and not crossed upon a mainboard;
 - Leave CPU fan cables minimum in length, and not near CPU;
 - Leave cables on panels and other spare cables tied in a computer case.
5. Make sure an EMI shielding attached to a case has properly been installed.
6. Make sure a 5.25" or 3.5" FDD and screws are fastened to an EMI shielding.
7. Make sure a case is closely in contact with EMI connected points.
8. Make sure there is no cleft in a case which is not deformed.
9. Make sure a PCI or AGP door is bound to a case.
10. Make sure cables of other devices (fans or some others) are fixed in a case.

TABLE OF CONTENTS

WHAT'S IN THE MANUAL	4
Quick Reference	4
About This Manual	4
1 INTRODUCTION	5
1.1 TO DIFFERENT USERS	5
FIRST-TIME DIY SYSTEM BUILDER.....	5
EXPERIENCED DIY USER	5
SYSTEM INTEGRATOR.....	5
1.2 ITEM CHECKLIST:	6
2 FEATURES	7
2.1 SPECIFICATIONS	7
3 HARDWARE INSTALLATION	10
3.1 STEP-BY-STEP INSTALLATION (Accessories of FN41V3)	10
STEP 1 Install the CPU	11
STEP 2 Set Jumpers	12
STEP 3 Install DDR SDRAM System Memory	12
STEP 4 Install Internal Peripherals in System Case	13
STEP 5 Mount the Mainboard on the Computer Chassis	14
STEP 6 Connect Front-Panel LEDs/Switches/USBs	15
STEP 7 Connect IDE and Floppy Disk Drives	16
STEP 8 Connect Other Internal Peripherals	17
STEP 9 Connect the Power Supplies	19
STEP 10 Install Add-on Cards in Expansion Slots	19
STEP 11 Connect External Peripherals to Back-Panel	20
STEP 12 System Boot Up For the First-Time	21
STEP 13 Install Drivers & Software Components	22
3.2 JUMPER SETTINGS	23
JUMPERS & CONNECTORS GUIDE	24
<i>Jumpers</i>	
Clear CMOS Setting (JP1).....	27

Back-Panel Connectors

VGA Port Connectors	28
COM1 Port Connector	28
Optional AV & S-Video Connector	28
IEEE1394a Port Connectors	28
LAN Port Connector	28
USB Port 1/2 Connectors	29
PS/2 Mouse & PS/2 Keyboard Port Connectors	29
Center/Bass-Out Port Connector	29
Rear-Out Port Connector	29
Line-Out Port Connector	29

Front-Panel Connectors

HDD LED Connector (HLED)	30
Green LED/Power LED Connector (GLED/PWR LED)	30
Hardware Reset Connector (RST)	31
ATX Power On/Off Switch Connector (PWON)	31
SPDIF In/Out Header (JP7)	32
Front Panel Audio Header (JP14)	32
Front Panel 1394a Header (JP14)	33
Extended USB Headers (JP11/JP14)	34

Internal Peripheral Connectors

Enhanced IDE and Floppy Connectors (IDE1/IDE2 & FLP1)	35
---	----

Other Connectors

ATX Power Supply Connectors (CN9/JP13)	36
CPU, System, and Chipset Fan Connectors (FAN1/2/3)	37
Audio CD_IN Connector (CN6)	37
Wireless KB/MS Header (JP2)	38
IR Header (JP5)	38
Extended Parallel Port Header (JP12)	39

AGP Protection LED (D16)	40
CPU Overtemperature LED (D14)	40
3.3 SYSTEM MEMORY CONFIGURATION	41
INSTALL MEMORY	41
UPGRADE MEMORY	41
4 SOFTWARE UTILITY	42
4.1 Mainboard CD Overview	42
4.2 Install Mainboard Software	43
4.2A Install nVIDIA Chipset Driver	44
4.2B Install VGA Device Driver	45
4.3 View the User's Manual	46
5 BIOS SETUP	47
5.1 ENTER BIOS	47
5.2 THE MAIN MENU	48
STANDARD CMOS FEATURES	50
ADVANCED BIOS FEATURES	52
ADVANCED CHIPSET FEATURES	55
INTEGRATED PERIPHERALS	58
POWER MANAGEMENT SETUP	61
PNP/PCI CONFIGURATIONS	64
PC HEALTH STATUS	65
CPU RATIO/VOLTAGE Control	67
LOAD FAIL-SAFE DEFAULTS	68
LOAD OPTIMIZED DEFAULTS	68
SET SUPERVISOR/USER PASSWORD	68
Save & Exit Setup	69
Exit Without Saving	69

WHAT'S IN THE MANUAL

Quick Reference

Hardware Installation >> Step-by-Step	Page 10
Jumper Settings >> A Closer Look	Page 23
Software Utility >> How to Install	Page 42
BIOS Setup >> How to Configure	Page 47

About This Manual

For First-Time DIY System Builder	Page 5
For Experienced DIY User	Page 5
For System Integrator	Page 5

1 INTRODUCTION

1.1 To Different Users

First-Time DIY System Builder

Welcome to the DIY world! Building your own computer system is not as difficult as you may think. To make your first computer DIY experience successful, right from the start, we have designed Chapter 3 Hardware Installation in a step-by-step fashion for all the first-time DIY system builders. Prior to installation, we suggest you read the whole manual to gain a complete understanding of your new FN41V3 mainboard.

Experienced DIY User

Congratulate on your purchase of the FN41V3 mainboard. You will find installing your new FN41V3 mainboard is quite easy. Bundled with an array of onboard functions, the highly-integrated FN41V3 mainboard provides you with a total solution to build the stablest and most reliable system. Referring to section 3.2 Jumper Settings and Chapter 4 Software Utility, you will find how to work out your new mainboard. Chapter 5 BIOS Setup also contains the relevant information on how to tune up your system to achieve higher performance.

System Integrator

You have wisely chosen FN41V3 to construct your system. FN41V3 incorporates all the state-of-the-art technology of the nForce2 Ultra 400 chipset from nVIDIA. Each integrates the most advanced functions you've ever found in a compact Small Form Factor ATX board.

1.2 Item Checklist:

Check all items with your FN41V3 mainboard to make sure nothing is missing. A complete package should include:

- * One Shuttle FN41V3 Mainboard

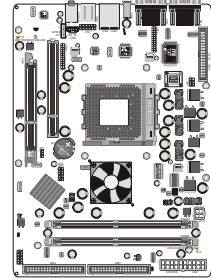

- * One ATA 133/100/66/33 Ribbon Cable



- * One Floppy Ribbon Cable

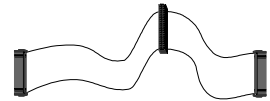

- * One Twin-Port USB Cable (optional)

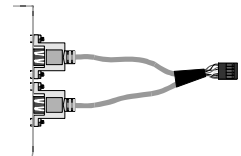

- * TV-Out Cable



- * FN41V3 User's Manual



- * One Bundled CD-ROM, including:
 - FN41V3 user's manual in PDF format
 - nVIDIA Chipset Driver
 - VGA Device Driver
 - Award Flashing Utility



2 FEATURES

FN41V3 mainboard is dedicatedly designed for demanding PC users who desire high performance and maximum intelligent features in a compact package.

2.1 Specifications

* CPU Support

Support Socket462 package CPU.

AMD AthlonXP/Athlon/Duron Processor with 200/266/333/400 MHz FSB.

* Chipset

Features nVIDIA nForce2 IGP N.B. and nVIDIA MCP-T S.B..

Onboard LAN

Realtek 8201BL, support 10Mb/s and 100Mb/s operation.

Onboard 1394a

Realtek 8801, support 400Mb/s, 200Mb/s, 100Mb/s data transfer rate.

Onboard Audio

Realtek ALC650, nVIDIA MCP-T support Stereo or AC-3 S/PDIF output.

* Versatile Memory Support

Integrated 128 bit TwinBank memory controller.

Two 184-pin DIMM slots to support up to 2GB of DDR200, DDR266, DDR333 compliant DDR SDRAM module.

* Expansion Slots

Provides one 3.0 compliant AGP slot and one 32-bit PCI slot.

* 6 USB Interface Onboard

➤ 2 USB connectors on back-panel and two sets of dual USB ports headers on mid-board.

* I/O Interface

Provides a variety of I/O interfaces:

➤ 1 Floppy interface for 3.5-inch FDD with 720KB, 1.44MB, or 2.88MB format or for 5.25-inch FDD with 360K or 1.2MB format.

➤ 2 x DB15 VGA connectors

➤ 1 x DB9 Serial connector

➤ 1 x AV & S-Video connector

-
- 2 x 1394a ports
 - 1 x LAN port
 - 2 x USB ports
 - 1 x PS/2 Mouse
 - 1 x PS/2 Keyboard
 - 1 x Center/Bass-Out port
 - 1 x Rear-Out port
 - 1 x Line-Out port

* **PCI Bus Master IDE Controller Onboard**

Two ultra DMA 133 bus master dual-channel IDE ports support up to four IDE devices (one Master and one Slave per channel).

The IDE bus implements data transfer speeds to 133/100/66/33MB/sec and supports enhanced PIO modes.

80-pin cable backward compatible legacy ATAPI devices, ATAPI IDE CD-ROM, CD-R, CD-RW, and LS-120 supports.

* **ATX Power Supply Connector**

ATX power supply unit can be connected to the onboard 20-pin ATX power connector, and 4-pin ATX power connector. The unit supports Suspend and Soft-On/Off modes by the dual-function power button.

* **Advanced Configuration and Power Interface**

Features four power-saving modes: S1 (Snoop), S3 (Suspend to RAM), S4 (Suspend to DISK), and S5 (Soft-Off). ACPI provides more efficient energy-saving features controlled by your operating system that supports OS Direct Power Management (OSPM) functionality.

* **System BIOS**

Provides licensed Award BIOS V6.0 PG on the 2Mb Flash ROM, and supports Green PC, Desktop Management Interface (DMI).

* **Form Factor**

System board conforms to small form factor ATX specification.

Board dimension: 254mm x 185mm.

*** Advanced Features**

- Low EMI - Built in spread spectrum. Unused PCI/SDRAM slots are shut off by the automatic clock for reducing EMI.
- Dual Function Power Button - The system can be in any of the two states: one is Suspend mode and the other is Soft-Off mode. Pushing the power button for less than 4 seconds places the system into Suspend mode. When the power button is pressed for longer than 4 seconds, the system will enter Soft-Off mode.
- Modem Ring Power-On - The system can be powered on automatically by the activation of modem ringing.
- CPU Multiplier Setting - This item allows users to adjust CPU Multiplier in BIOS.
- CPU/DIMM/AGP Voltage Setting - These items allow users to adjust CPU/DIMM/AGP Voltage in BIOS.

*** Intelligent Features**

- Voltage Monitoring - Monitors various voltages of key elements, such as the CPU, and other critical system voltage levels to ensure a stable current passing through mainboard components.
- Fan Status Monitoring - To prevent the CPU from overheating, the CPU fan is monitored by RPM, with which the cooling fan is required.
- Temperature Monitoring - This item allows users to make sure whether the CPU or system runs under a suitable temperature.
- CPU Fan Speed Control - This SMART BIOS enables variable fan speed and CPU temperature control features.

3 HARDWARE INSTALLATION

Before removing/installing any of these devices: CPU, DIMMs, Add-On Cards, and Cables, please unplug the onboard power connector.

This section outlines how to install and configure your mainboard. Referring to the following mainboard layout helps you identify various jumpers, connectors, slots, and ports.

3.1 Step-by-Step Installation (Accessories Of FN41V3)

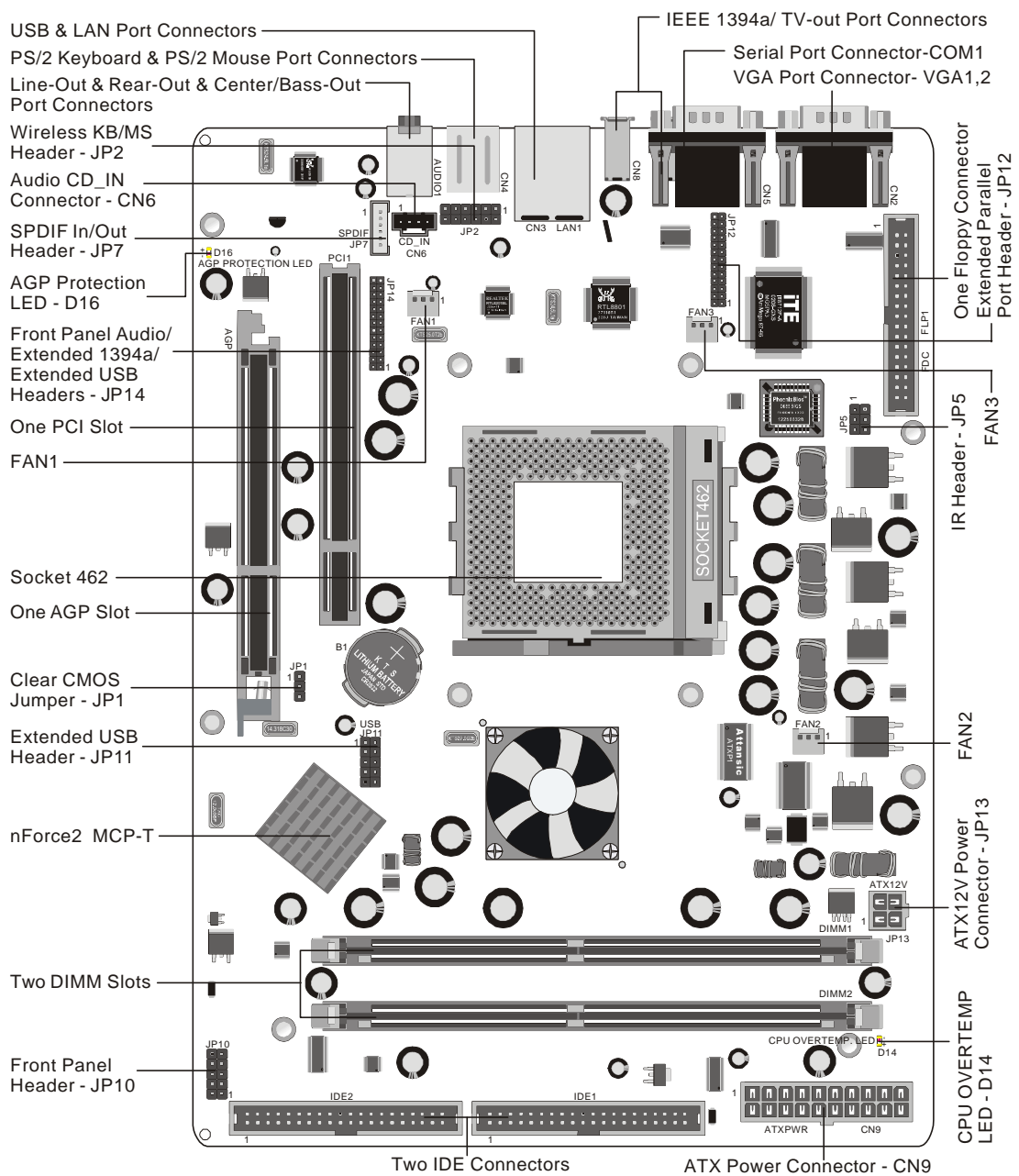

Step 1

Install the CPU:

1. Locate the CPU ZIF (Zero Insertion Force) socket on the upper-right sector of your mainboard (between the back-panel connectors and the DIMM memory slots).
2. Pull the CPU ZIF socket lever slightly sideways away from the socket to unlock the lever, and then bring it to an upwardly vertical position.
3. Place your AMD AthlonXP/Athlon/Duron processor in the socket. Note that the CPU's edges have been purposely designed non-symmetrically to prevent from inserting the processor in the wrong direction. The following diagram demonstrates the correct placement of the CPU in the ZIF socket. You can see that the two blunt-edged corners should face towards the socket lever.

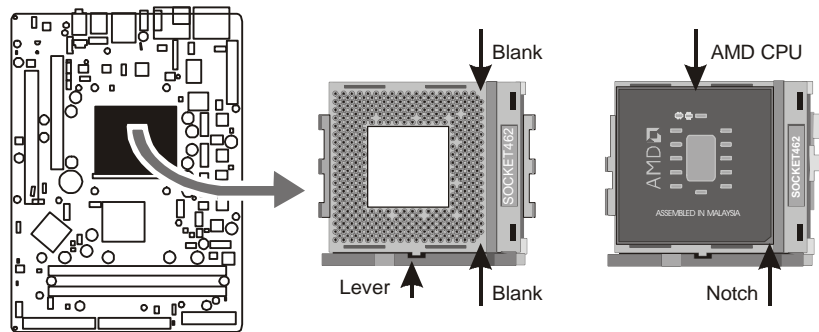

4. Slightly push the AMD AthlonXP/Athlon/Duron processor into the socket without applying excessive force while making sure there is no gap between CPU and socket. Then lower the socket-lever all the way down to its horizontal position and lock it to secure the CPU in place.
5. The AMD AthlonXP/Athlon/Duron processor requires a set of heatsink/fan to ensure proper cooling of the processor. If heatsink/fan have not been already mounted on your CPU, you must purchase the heatsink/fan separately and have it installed. Plug the cable through the heatsink/fan in the CPU fan power connector located nearby. Note that there are several types of CPU fan connectors. Normally, if your mainboard supports the hardware monitoring function, a 3-pin fan power connector should allow your system to detect the CPU fan's speed. The CPU fan can also run with a 2-pin fan power connector, however, detection of CPU fan's speed is not supported. Another type of CPU fan may feature a large 4-pin fan power connector, which does not support CPU fan's speed detection and must be directly connected to the system's power supply unit. Please refer to the following diagram.

Step 2.

Set Jumpers

This mainboard is jumperless! The default jumper settings have been set for the common usage standard of this mainboard. Therefore, you do not need to reset the jumpers unless you require special adjustments as any of the following cases:

1. Clear CMOS

For first-time DIY system builders, we recommend that you do not change the default jumper settings if you are not totally familiar with the mainboard configuration procedures. The factory-set default settings are tuned for optimum system performance. For the advanced users who wish to customize their system, section 3.2 Jumper Settings will provide detailed information on how to configure your mainboard manually.

Caution: If you did not place the battery appropriately, which may cause risk of explosion. please refer to the related rule for the dispose of used batteries.

Step 3.

Install DDR SDRAM System Memory

To install memory, insert DDR SDRAM memory module(s) in DIMM slot(s). Note that DDR SDRAM modules are directional and will not go in the DIMM slots unless properly oriented. After the module is fully inserted into the DIMM slots, lift the clips of both sides of the DIMM slot to lock the module in place.

DDR SDRAM

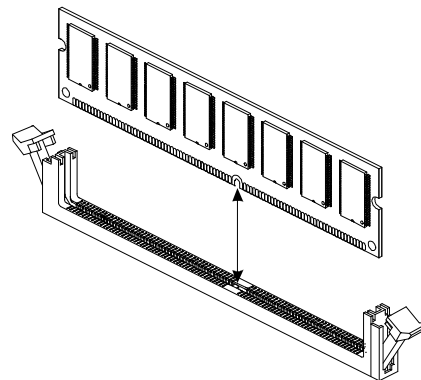

Step 4

Install Internal Peripherals in System Case

Before you place the mainboard into your system case, we recommend that you first assemble all the internal peripheral devices into the computer housing, including, but not limited to, the hard disk drive (IDE/HDD), floppy disk drive (FDD), CD-ROM drive, and ATX power supply unit.

To install IDE & FDD drives, follow these procedures:

1. Set the required jumpers on each device according to the instructions provided by the manufacturer. (IDE, HDD, and CD-ROM have to set jumpers to Master or Slave mode depending on whether you install more than one device of each kind.)
2. Connect the IDE cable and FDD cable on the back-panel of the internal peripheral devices to the corresponding headers on board. Note that the cable should be oriented with its colored stripe (usually red or magenta) connected to pin#1 of the IDE or FDD connector on the mainboard and on the device as well.
3. Connect an available power cable from your system power supply unit to the back-panel of each peripheral device. Note that the power cable is directional and cannot fit in if not properly positioned.

Step 5

Mount the Mainboard on the Computer Chassis

1. You may find there are a lot of mounting holes on your computer chassis and mainboard. To match the holes on both properly, the key point is to make the back-panel of the mainboard in a close fit with your system case, as shown below.

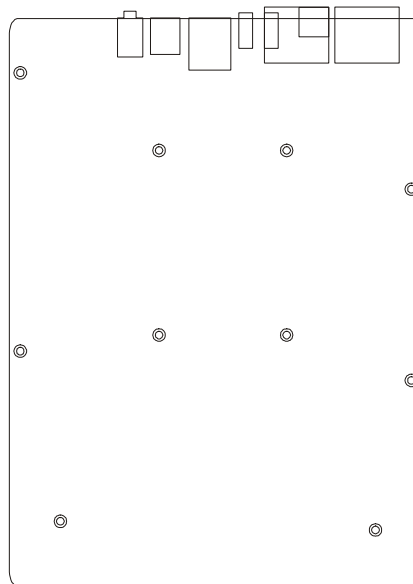

2. Position the studs between the chassis and the mainboard. The studs are used to fix the mainboard and to keep a certain distance between them, for avoiding any electrical shorts in-between.
(If your computer case is already equipped with mounting studs, you need to tighten the screws to attach the mainboard.)

Note: In most computer housings, you can find 4 or more holes to place studs for fixing the mainboard. If there aren't enough matching holes, screw at least 4 studs to ensure the proper attachment of the mainboard.

Step 6

Connect Front-Panel LEDs/Switches/USBs

You can find there are several cables existing in the system case and originating from the front-panel devices (HDD LED, Green LED, Reset switch, and USB devices etc.). These cables serve to connect the front-panel LEDs, switches, and USB connectors to JP10 and JP11/JP14, as shown below.

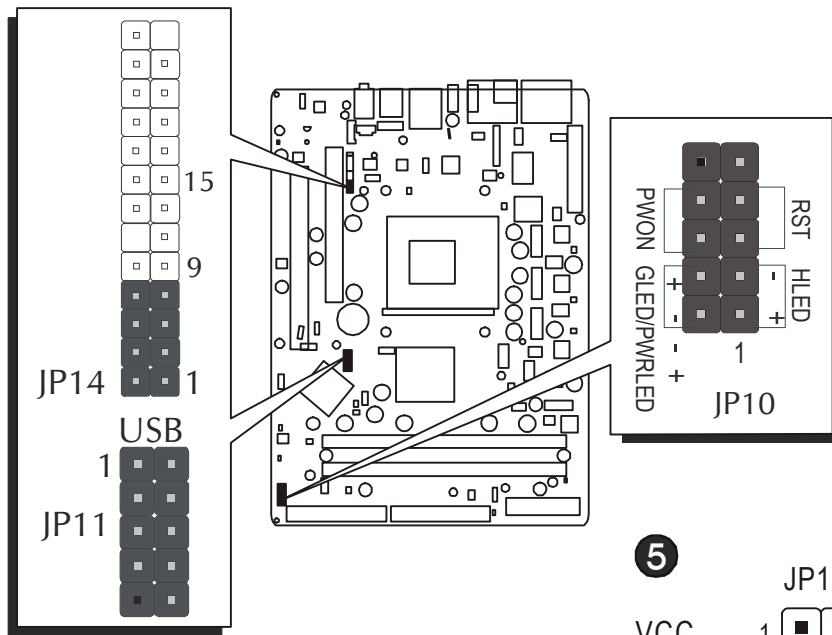

1. HDD LED (HLED)
2. Green LED/Power LED (GLED/PWR LED)
3. Hardware Reset Switch (RST)
4. ATX Soft Power On/Off (PWON)
5. Extended USB Headers (JP11/JP14)

5

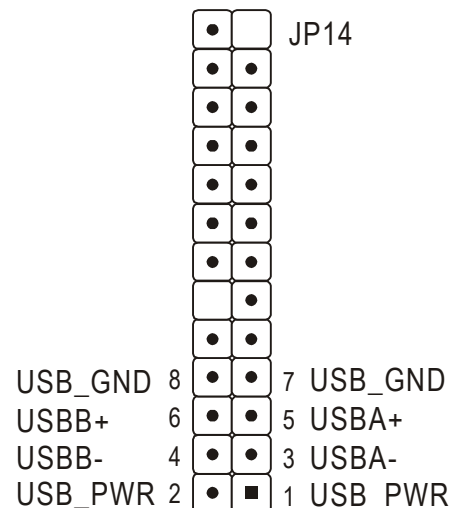
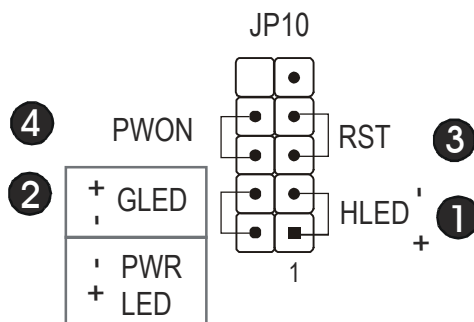
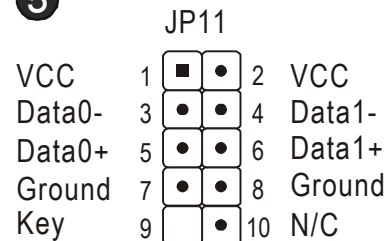

Step 7

Connect IDE and Floppy Disk Drives

1. IDE cable connectors

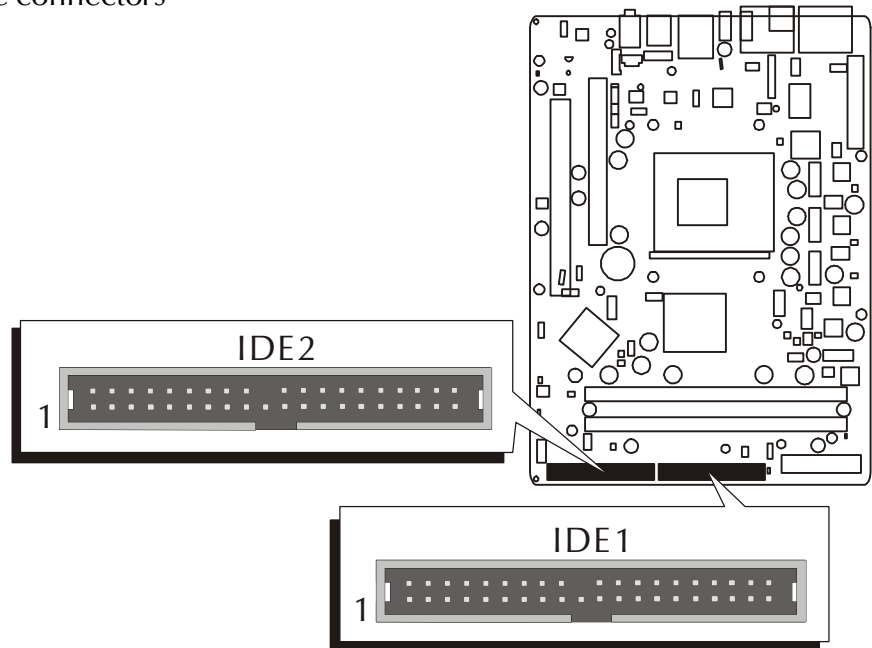

2. Floppy cable connector

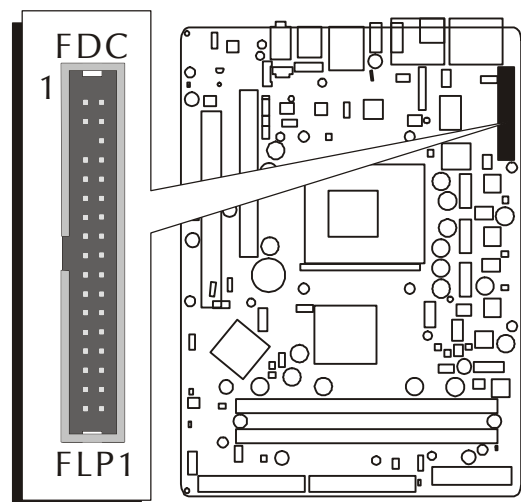

Step 8

Connect Other Internal Peripherals

1. Wireless KB/MS header (JP2)

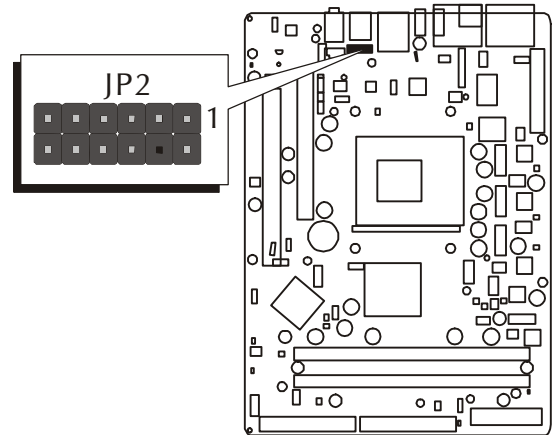

2. Audio CD_IN (CN6) connector;
Front panel audio header (JP14)

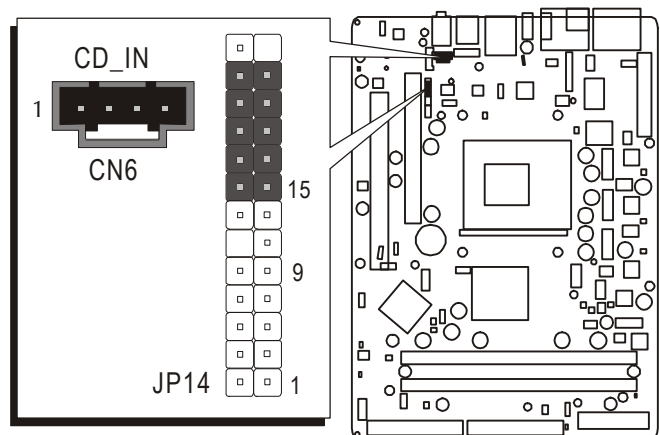

3. SPDIF in/out header (JP7)

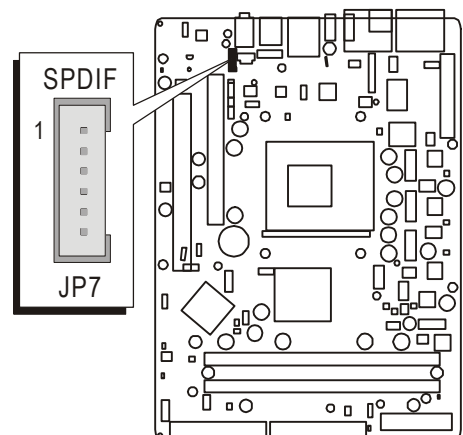

4. Front panel 1394a header (JP14)

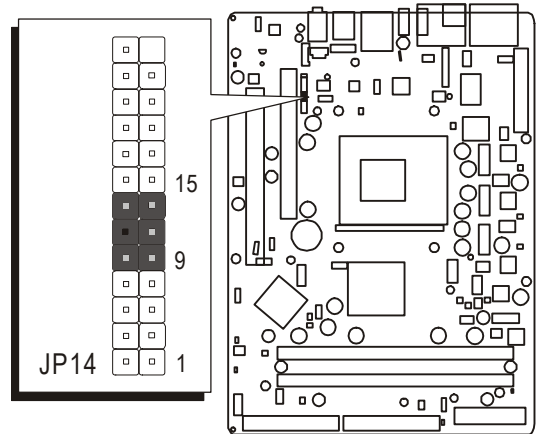

5. Extended parallel port header (JP12)

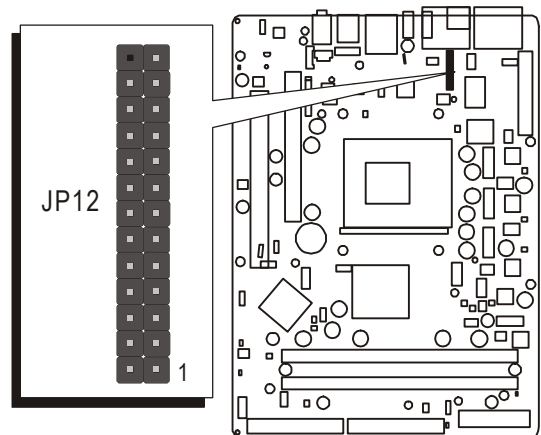

6. IR header (JP5)

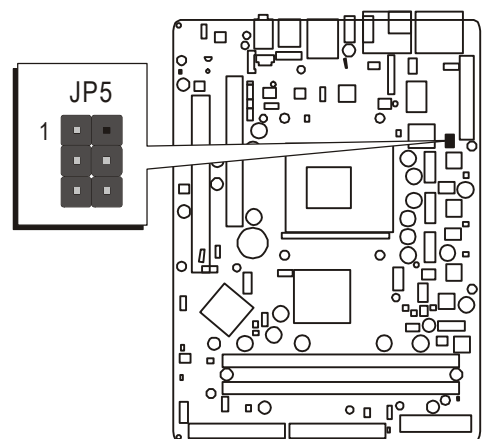

Step 9

Connect the Power Supplies

1. System power connectors (CN9/JP13)

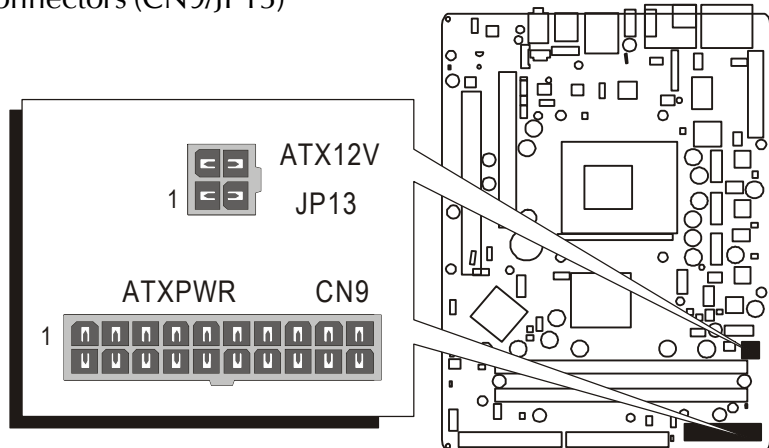

Step 10

Install Add-On Cards in Expansion Slots

1. Accelerated Graphics Port (AGP) Card

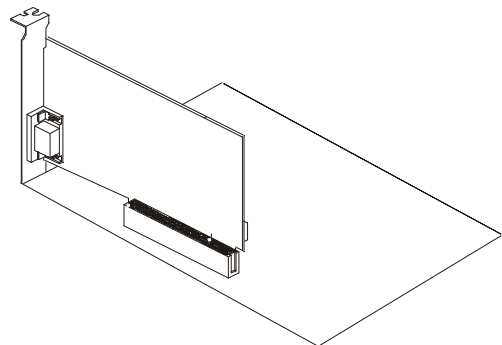

2. PCI Card

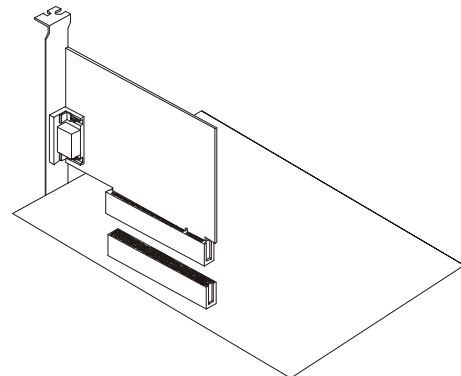

Step 11

Connect External Peripherals to Back-Panel

You are now ready to connect the external peripherals to your system's back-panel.

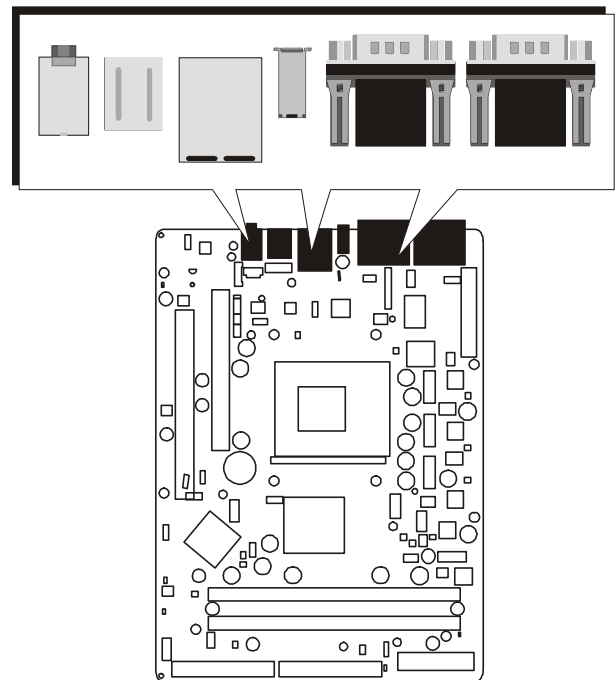

1. VGA2 Port
2. VGA1 Port
3. Serial Port (COM1)
4. TV-out Port
5. IEEE1394a Ports #0 / #1
6. LAN Port
7. USB 2.0 Ports #0 / #1
8. PS/2 Mouse Port
9. PS/2 Keyboard Port
10. 5.1-Channel Front-Out Port
11. 5.1-Channel Rear-Out Port
12. 5.1-Channel Center/Bass Port

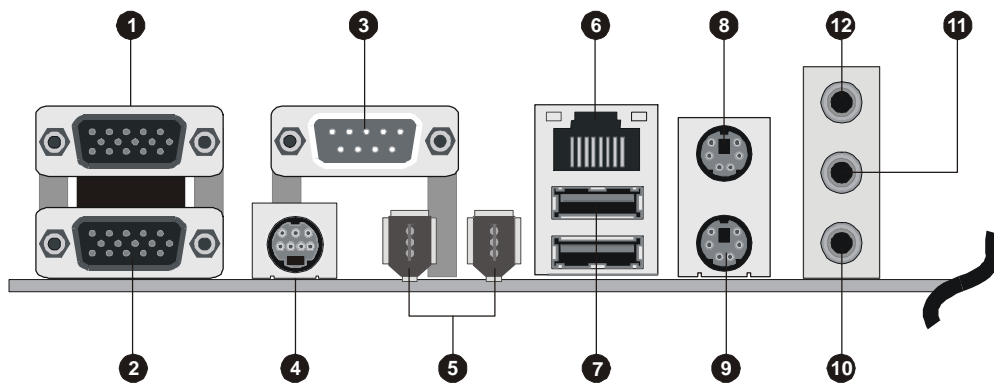

Step 12

System Boot Up For the First-Time

To ensure your system completely and correctly installed, please refer to the above installation steps once again before first booting up your system.

1. Insert a system-bootable floppy disk (DOS 6.2X, Windows 9X/NT, or others), which contains the FDISK and FORMAT utilities.
2. Turn on the system power.
3. First, you need to use the FDISK utility to create a primary partition of the hard disk. You can also add an extended partition if your primary partition does not use all of the available hard disk space. If you choose to add an extended partition, you will have to create one or more logical partitions to occupy all the space available to the extended partition. The FDISK utility will assign a drive letter (i.e. C:, D:, E:,.....) to each partition shown in the FDISK program. After the FDISK procedure, reboot your system by using the same disk.

Note: DOS 6.2X and Windows 95A can only support up to 2.1GB of HDD partition. If you use the FDISK utility with one of the operating systems mentioned above, you can only install your HDD into any partitions no larger than 2.1GB.

4. Now, use the FORMAT utility to format all the partitions you've created. When formatting the primary partition (C:), key in the command, "FORMAT C:/S."

Note: FORMAT C:/S can transfer all the necessary system files into the primary partition of your hard disk. Afterwards, your HDD will become a bootable drive.

5. Install all the necessary drivers for CD-ROM, Mouse, etc.
6. Setup the complete operating system according to your OS installation guide.

Step 13

Install Drivers & Software Components

Please note that all the system utilities and drivers are designed for Win 9x/2000/ME/NT/XP operating systems. Make sure your operating system is already installed before running the installation programs on CD-ROM.

1. Insert the FN41V3 bundled CD-ROM into your CD-ROM drive. The auto-run program will display the main installation window on screen.
2. Choose "Install Mainboard FN41V3 Series Driver"
3. Choose "Install nVIDIA Chipset driver" and complete it.
3. Choose "Install VGA Device Driver" and complete it.
4. Quit (from the auto-run installation program).

3.2 Jumper Settings

Several hardware settings are made through the use of mini jumpers to connect jumper pins on the mainboard. Pin #1 could be located at any corner of jumpers, and the corner with a white right angle stands for Pin #1. There are several types of Pin #1 as shown below:

3-pin and multi-pin (> 3) jumpers shown as follows:

Pin #1 to the left:



Pin #1 on the top:





Pin #1 to the right:



Pin #1 on the bottom:



Jumpers with two pins capped are shown as  for Close [On] or  for Open [Off]. To do this, please place a plastic mini cap on the desired pair of pins.

Caution!

1. Do not remove the mainboard from its antistatic protective packaging until you are ready to install it.
2. Carefully hold the mainboard by its edges and avoid touching its components. When putting the mainboard down, place it on top of its original packaging film, with the component side up.
3. Wear an antistatic wrist strap or take other suitable measures to prevent electrostatic discharge (ESD) as handling this equipment.

Jumpers & Connectors Guide

Refer to the mainboard layout on page 10 and this section to help you identify jumpers, slots, and connectors along with their assigned functions.

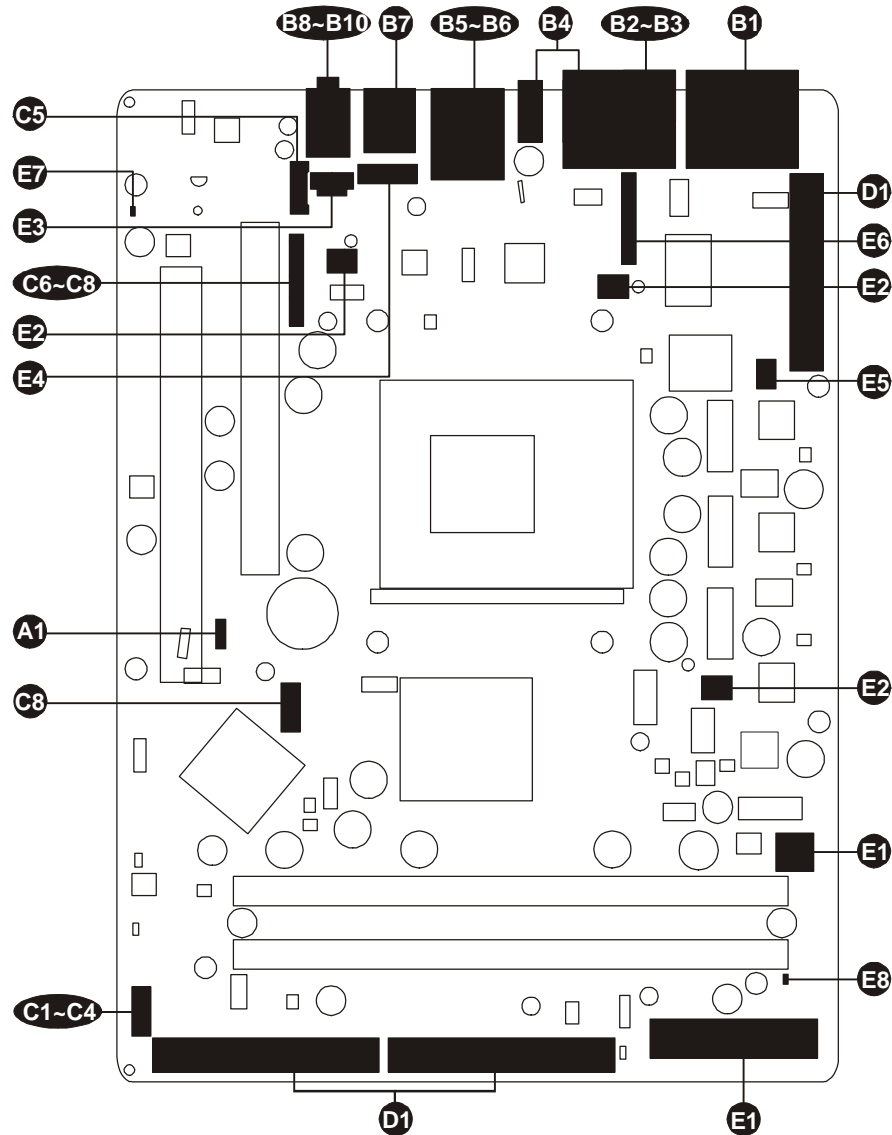

CPU/Memory/Expansion Slots

- Socket A : CPU socket for AMD Athlon XP/Athlon/Duron, 462-pin processors
- DIMM1/2 : Two DIMM slots for 64, 128, 256, 512 MB, and 1GB of 2.5V DDR SDRAM
- AGP : One AGP slot supports up to 8X AGP device.
- PCI : One 32-bit PCI expansion slot

Jumpers

A1 JP1 : Clear CMOS setting

Back-Panel Connectors

B1 VGA1,2 : VGA port
B2 COM1 : Serial port
B3 AV & S-Video : AV and S-Video port
B4 1394a : 1394a ports #0/#1
B5 LAN : LAN port
B6 USB : USB ports #0/#1
B7 MS : PS/2 Mouse port
KB : PS/2 Keyboard port
B8 CENTER/BASS : Center/Bass-Out port
B9 REAR-OUT : Rear-Out port
B10 LINE-OUT : Front-Out port

Front-Panel Connectors

C1 HLED : HDD LED
C2 GLED/PWR LED : Green LED/Power LED
C3 RST : Hardware reset switch
C4 PWON : ATX power on/off switch
C5 JP7 : Front panel SPDIF in/out header
C6 JP14 : Front panel audio header
C7 JP14 : Front panel 1394a header
C8 JP11/JP14 : Extended USB headers

Internal-Peripheral Connectors

D1 IDE1 : IDE primary interface (dual-channel)
D1 IDE2 : IDE secondary interface (dual-channel)
D1 FLP1 : Floppy disk drive interface

Other Connectors

E1	CN9/JP13	: ATX power supply connectors
E2	FAN1	: CPU fan connector
E2	FAN2	: System fan connector
E2	FAN3	: Chipset fan connector
E3	CN6	: Audio CD_IN connector
E4	JP2	: Wireless keyboard/mouse header
E5	JP5	: IR header
E6	JP12	: Extended parallel port header
E7	D16	: AGP protection LED
E8	D14	: CPU overtemperature LED

Jumpers

A1 Clear CMOS Setting (JP1)

JP1 is used to clear CMOS data. Clearing CMOS will result in permanently erasing previous system configuration settings and the original factory-set system settings.

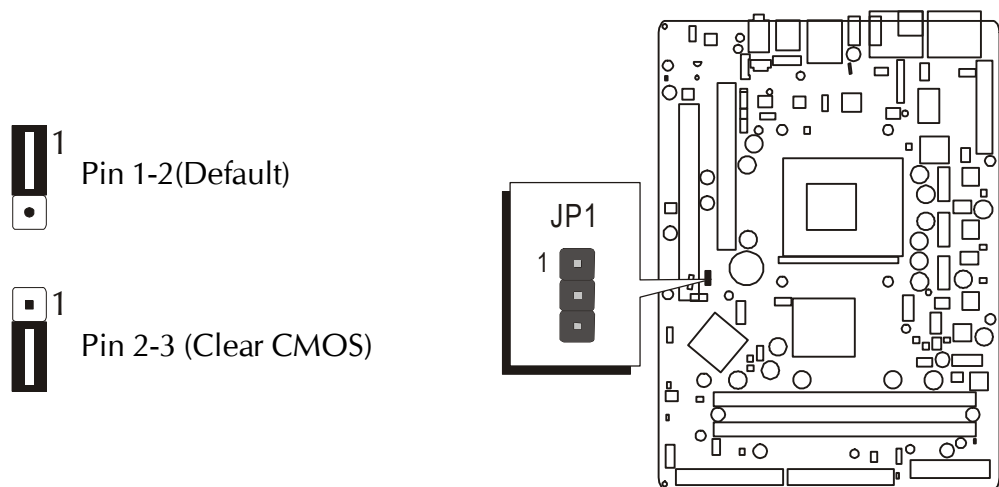

- Step 1. Turn off the system power (PC→ Off).
- Step 2. Remove the ATX power cable from the ATX power connector.
- Step 3. Remove the jumper cap from pins 1-2.
- Step 4. Place the jumper cap on pins 2-3 for a few seconds.
- Step 5. Restore the jumper cap to pins 1-2.
- Step 6. Plug the ATX power cable into the ATX power connector.
- Step 7. Turn on the system power (PC→ On).

☞ **Back-Panel Connectors**

B1 VGA Port Connectors

Two 15-pin VGA connectors is located at the rear panel of the mainboard.

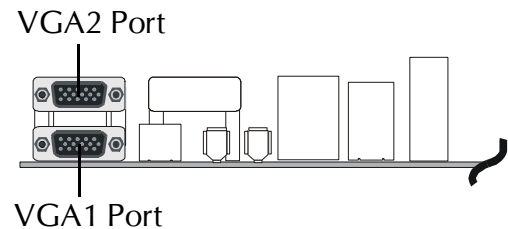

B2 COM1 Port Connector

This mainboard can accommodate one serial device on COM1. Attach a serial device cable to the DB9 serial port COM1 at the back-panel of your computer.

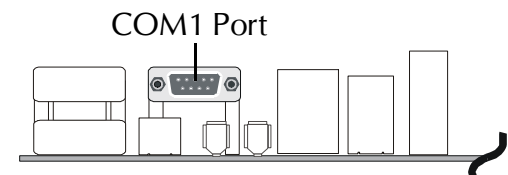

B3 AV & S-Video Connector

This mainboard can accommodate an AV and S-Video port on back-panel.

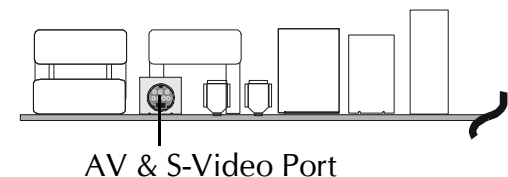

B4 IEEE 1394a Port Connectors

This mainboard offers two 1394a ports on back-panel. Plug each device jack into an available 1394a connector.

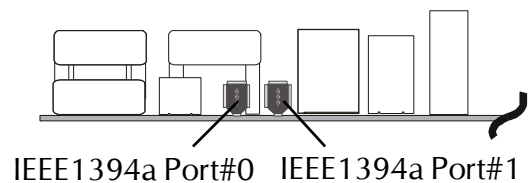

B5 LAN Port Connector

This mainboard can accommodate one device on LAN. Attach a RJ45 cable to the LAN port at the back-panel of your computer.

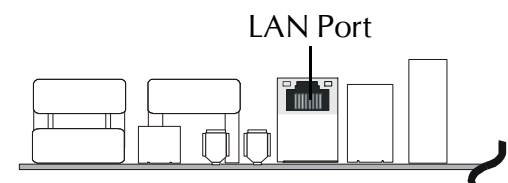

B6 USB Port 1/2 Connectors

Two female connectors USB1/USB2 share the same USB (Universal Serial Bus) bracket at the rear panel of your FN41V3 mainboard. Plug each USB device jack into an available USB1/USB2 connector.

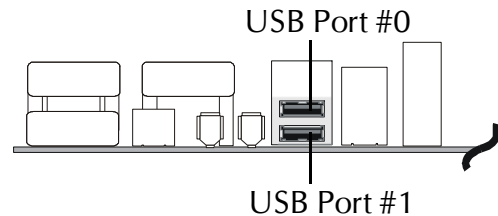

B7 PS/2 Mouse & PS/2 Keyboard Port Connectors

Two 6-pin female PS/2 Mouse & Keyboard connectors are located on the rear panel of the mainboard. In a desktop computer, the PS/2 Mouse connector is situated on the top of the PS/2 Keyboard connector. In a tower computer, the PS/2 Mouse connector is located on the rightside of the PS/2 Keyboard connector.

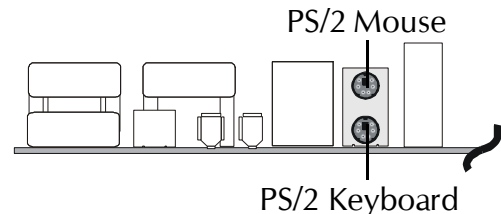

B8 Center/Bass-Out Port Connector

Center/Bass-Out is a stereo output port through which the combined signal of all internal and external audio sources on the board is output. It can be connected to 1/8-inch TRS stereo headphones or to center/bass amplified speakers.

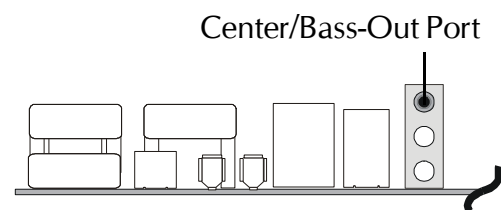

B9 Rear-Out Port Connector

Stereo out of rear (surround) channel.

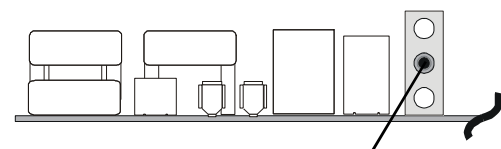

B10 Line-Out Port Connector

Line-Out is a stereo output port through which the combined signal of all internal and external audio sources on the board is output. It can be connected to 1/8-inch TRS stereo headphones or to amplified speakers.

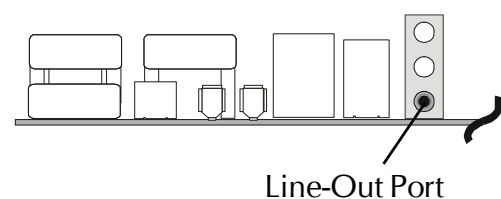

☞ **Front-Panel Connectors**

④ **HDD LED Connector (HLED)**

Attach a connector cable from the IDE device LED to the 2-pin (HLED) header. The HDD LED lights up whenever an IDE device is active.

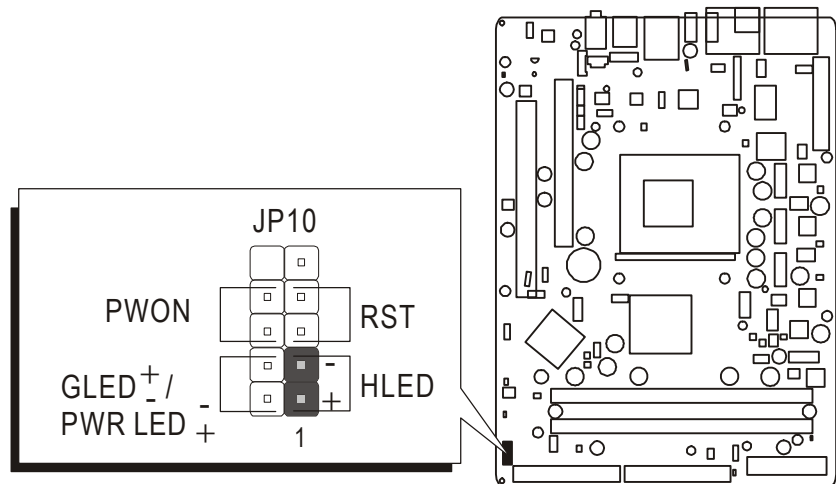

⑤ **Green LED/Power LED Connector (GLED/PWR LED)**

This header is dual color LED function. Dual color LED function is defined by either Green LED or Power LED, the header can be in these states. The Green LED indicates that the system is currently in one of the power saving mode (Doze/Standby/Suspend). When the system resumes to normal operation mode, the Green LED will go off, the Power LED on. The Power LED will go off during power saving mode. Attach a 2-pin Green LED/Power LED cable to (GLED/PWR LED) header.

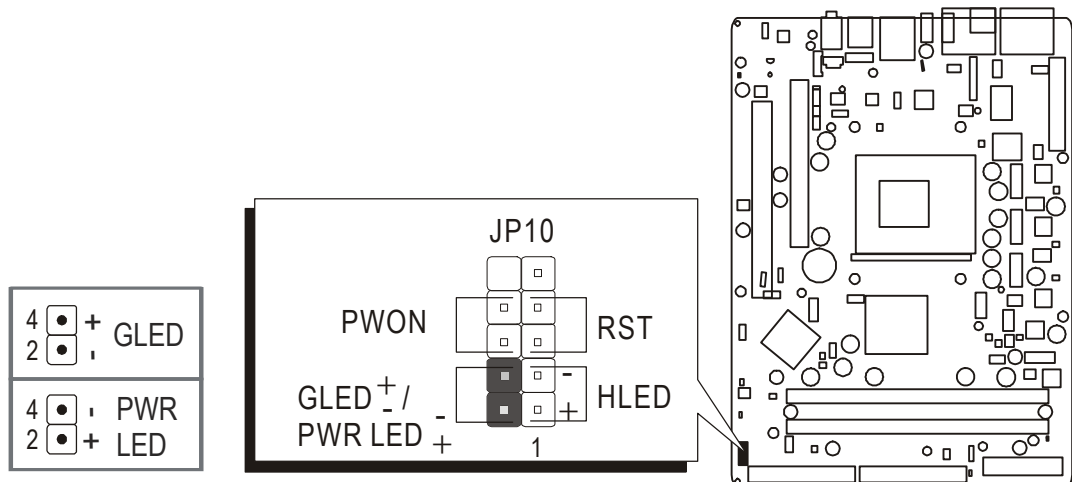

③ Hardware Reset Connector (RST)

Attach a cable to the 2-pin (RST) header. Pressing the reset switch causes the system to restart.

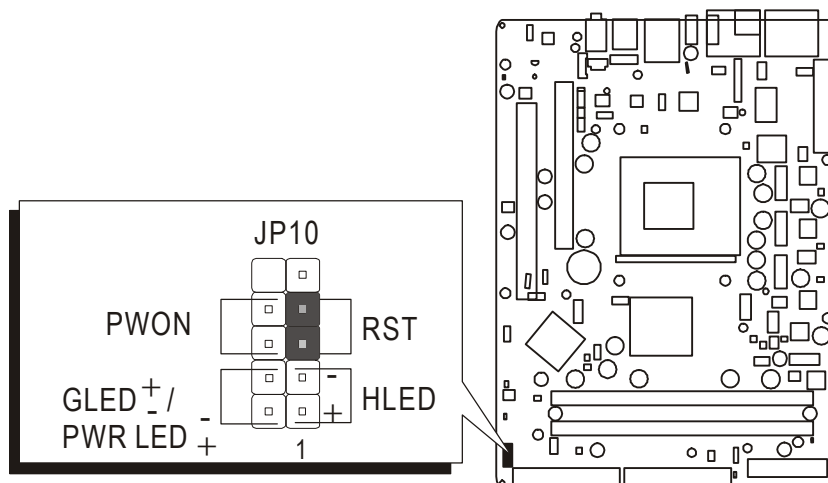

④ ATX Power On/Off Switch Connector (PWON)

The Power On/Off Switch is a momentary type switch used for turning on or off the ATX power supply. Attach a connector cable to the 2-pin (PWON) header on the mainboard.

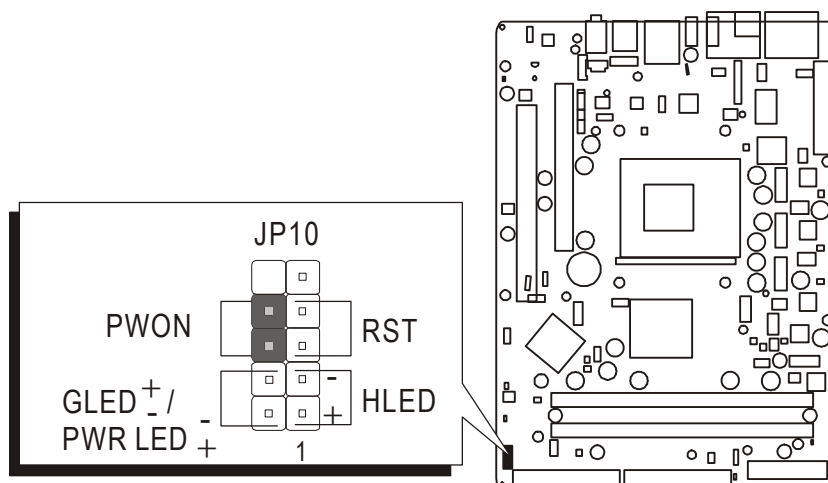

Note : Please notice all the LED connectors are directional. If your chassis's LED does not light up during running, please change it to the opposite direction.

65 SPDIF In/Out Header (JP7)

Port JP7 can be used to connect a special device.

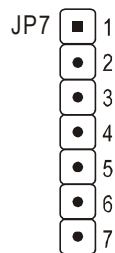

Pin Assignments:

1 = SPDIF_IN	2 = GND
3 = AVDD (+5V)	4 = GND
5 = AVDD (+5V)	6 = SPDIF_OUT

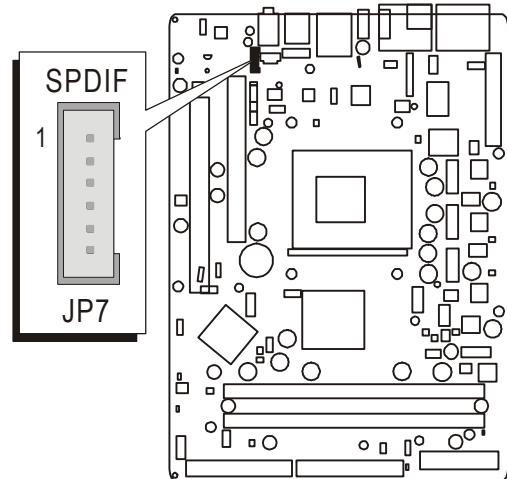

66 Front Panel Audio Header (JP14)

This header allows users to install an auxiliary Front-Oriented Audio port for easier access. Either the Line-Out port connector on back-panel or the Audio header is available at the same time. If you would like to use the Audio header on front-panel, please remove all jumpers from it and install your special extra audio cable instead. Two mini jumpers must be setted on pins 21-22 and pins 23-24 when this header is not used.

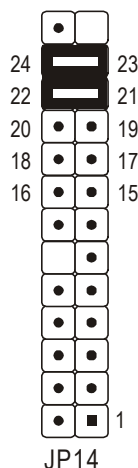

Pin Assignments:

15 = AUDIO_GND	16 = AUDIO_GND	17 = FRONT_MIC
18 = MIC_PWR	19 = LINE_IL	20 = LINE_IR
21 = LINE_OR	22 = LINE_OR	23 = LINE_OL
24 = LINE_OL		

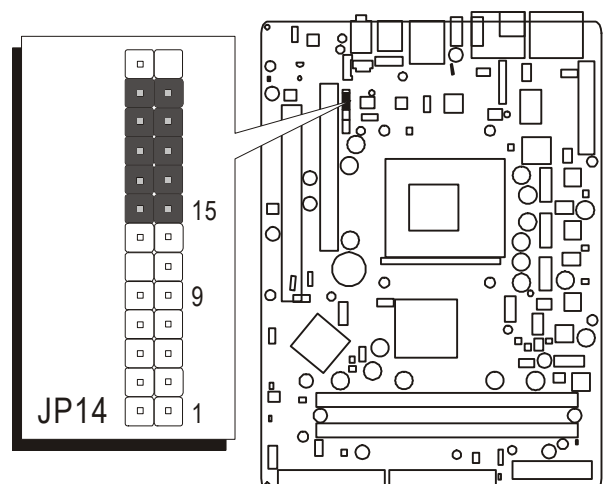

67 Front Panel 1394a Header (JP14)

The header is used to connect the cable attached to the 1394a connector which is mounted on front panel or back panel. But the 1394a cable is optional at the time of purchase.

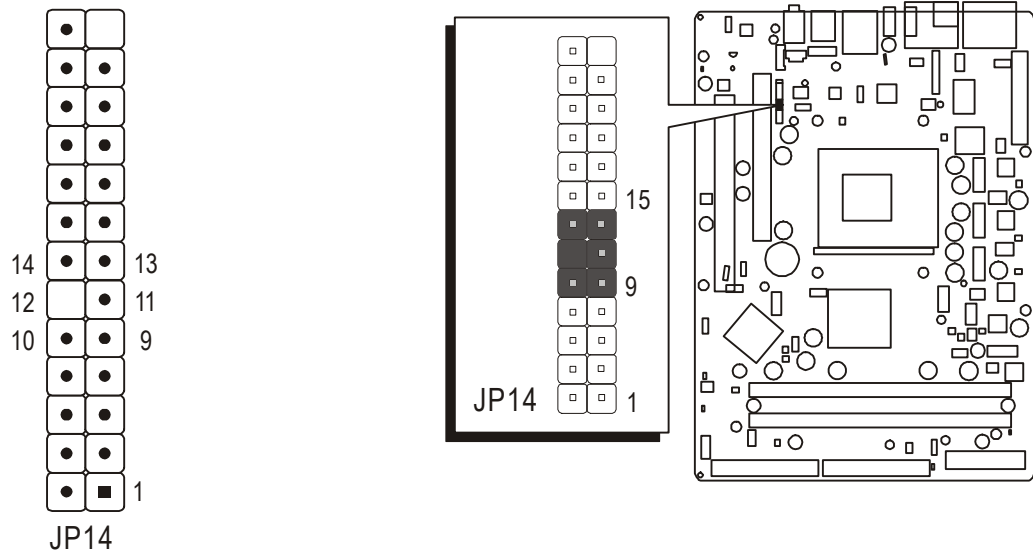

Pin Assignments:

9 = TPA +	10 = TPA -
11 = 1394_GND	12 = Key
13 = TPB +	14 = TPB -

③ Extended USB Headers (JP11/JP14)

Headers JP11 and JP14 are used to connect cables to USB connectors mounted on front-panel or back-panel. The USB cable is optional at the time of purchase.

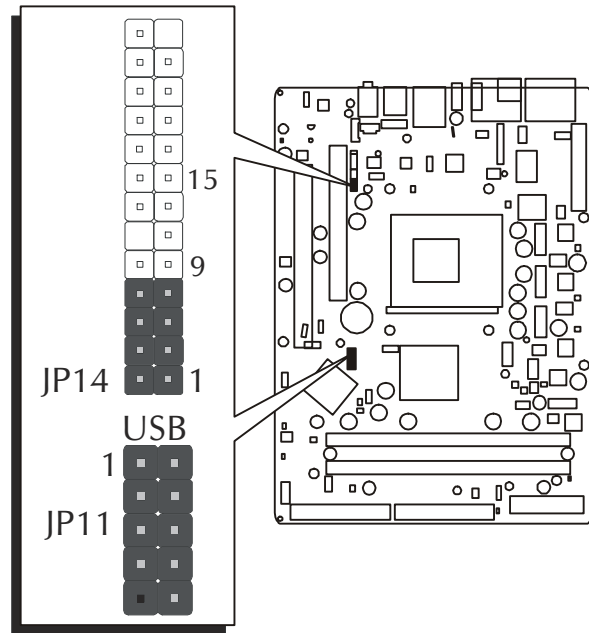

Pin Assignments:

1 = VCC	2 = VCC	3 = Data0-	4 = Data1-
5 = Data0+	6 = Data1+	7 = Ground	8 = Ground
9 = Key	10 = N/C		

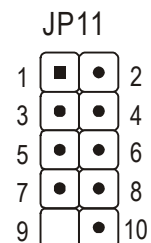

Pin Assignments:

1 = USB_PWR	2 = USB_PWR	3 = USBA-
4 = USBB-	5 = USBA+	6 = USBB+
7 = USB_GND	8 = USB_GND	

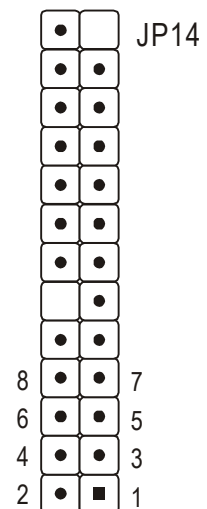

☞ **Internal Peripheral Connectors**

DI Enhanced IDE and Floppy Connectors (IDE1/IDE2 & FLP1)

FN41V3 mainboard features two 40-pin dual-channel IDE device connectors (IDE1/IDE2), providing support for up to four IDE devices, such as CD-ROM and Hard Disk Drive (HDD). This mainboard also includes one 34-pin floppy disk controller (FDC) to accommodate the Floppy Disk Drive (FDD). Moreover, this mainboard comes with one 80-pin ATA 133/100/66/33 ribbon cable to connect IDE HDD, and one 34-pin ribbon cable for FDD connection.

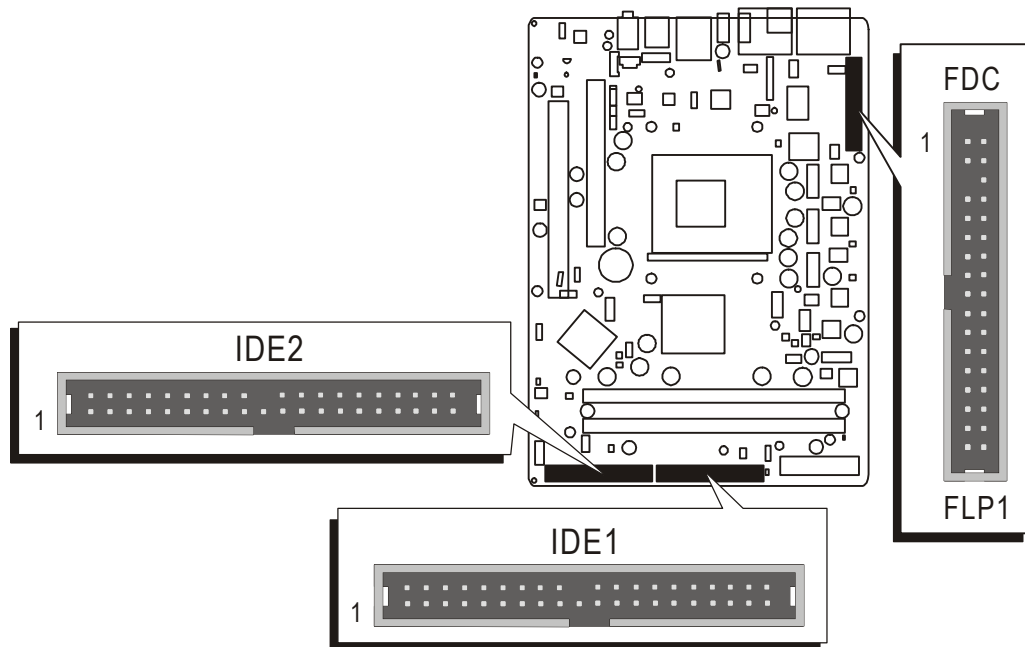

Important: Ribbon cables are directional; therefore, connect the red cable stripe to the same side.

☞ **Other Connectors**

㉑ ATX Power Supply Connectors (CN9/JP13)

This motherboard uses 20-pin ATX power header (ATXPWR, CN9), and comes with the other one header (ATX12V, JP13). Please make sure you plug each in the right direction. It is essential to have these two power supply connectors plugged or your system won't boot up.

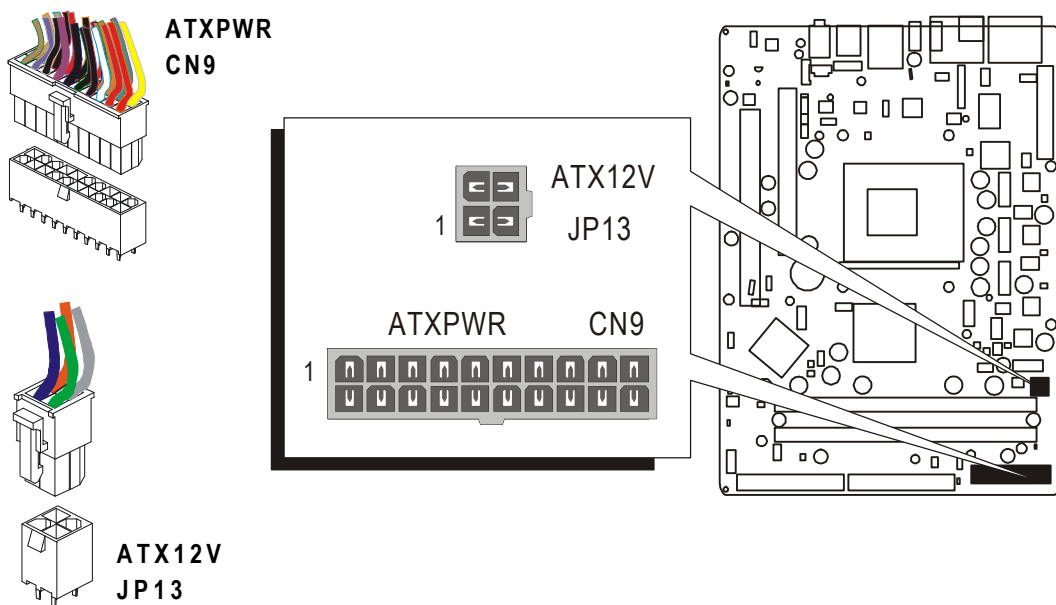

A traditional ATX system remains in the power-off stage when AC power resumes from power failure. However, it is inconvenient for a network server or workstation if there is not an UPS to execute power-on. Thus, this motherboard supports an AC Power Auto Recovery function to solve this problem. You may enable the function, "PWRON After PWR-Fail," in the sub-menu of "Power Management Setup" within the BIOS setup program.

- | | |
|---------|---|
| Note 1: | The ATX power connector is directional and will not go in unless the guides match perfectly, making sure that pin#1 is properly positioned. |
| Note 2: | Make sure the latch of the ATX power connector clicks into place to ensure a solid attachment. |
| Note 3: | Your ATX power supply must be supplied to ACPI + 5V stand-by power and at least 720mA compatible. |
| Note 4: | Make sure your power supply have enough power for higher speed processor installed. |

E2 CPU, System, and Chipset Fan Connectors (FAN1/2/3)

The mainboard provides three onboard 12V cooling fan power connectors to support the CPU (FAN1), system (FAN2), and chipset (FAN3).

Note: Both cable wiring and type of plug may vary, which depend on the fan maker. Keep in mind that the red wire should always be connected to the +12V header and the black wire to the ground (GND) header.

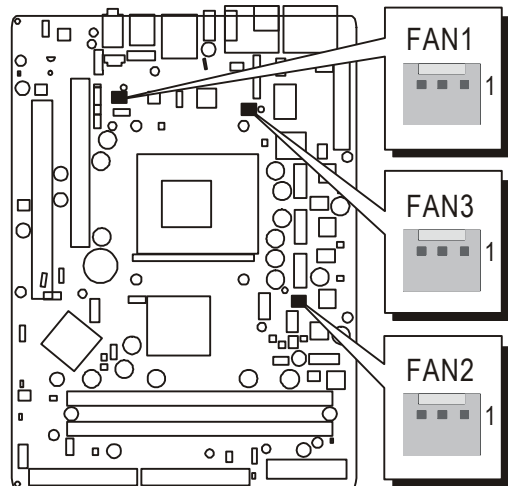
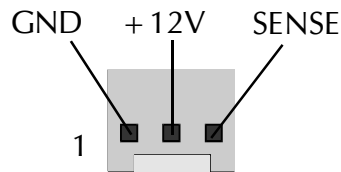

E3 Audio CD_IN Connector (CN6)

Port CN6 (Black) can be used to connect the stereo audio input from CD-ROM, TV-tuner or MPEG card.

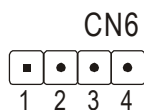

Pin Assignments:

- 1 = CD-IN (Left)
- 2 = Ground
- 3 = Ground
- 4 = CD-IN (Right)

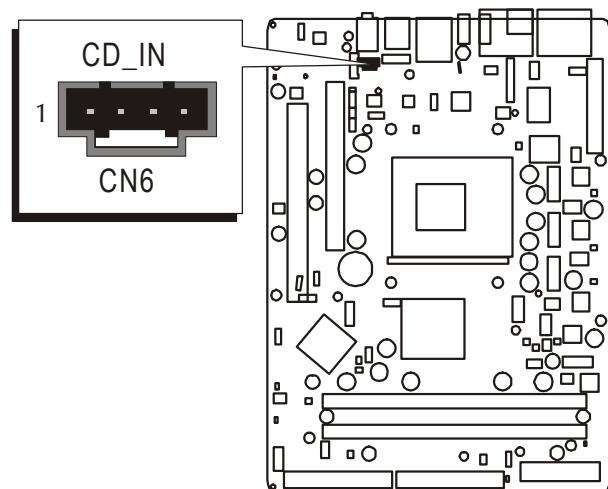

E4 Wireless KB/MS Header (JP2)

Port JP2 can be used to connect wireless keyboard and mouse devices.

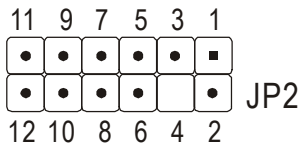

Pin Assignments:

1 = VCC	2 = VCC
3 = Ground	4 = Key
5 = MS_CK	6 = MCLK
7 = MS_DT	8 = MDAT
9 = KB_CK	10 = KCLK
11 = KB_DT	12 = KDAT

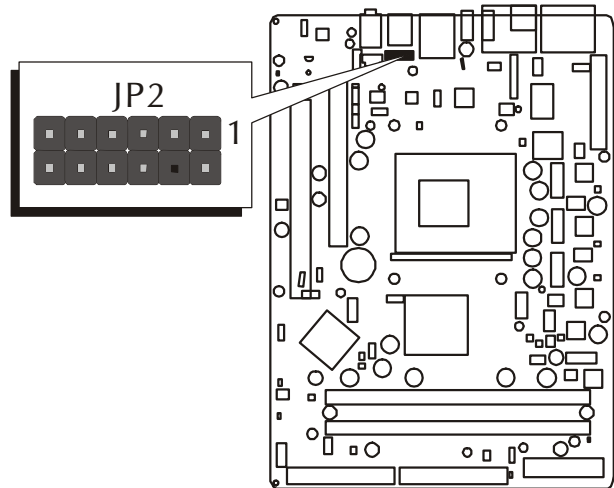

E5 IR Header (JP5)

If you have an Infrared device, this mainboard can implement IR transfer function. This mainboard supports IrDA, ASKIR, or SCR transfer mode. To enable this function, attach a 6-pin infrared device cable to the IR (JP5) header. Please note that every pin is properly allocated. If not, your IR device may be damaged.

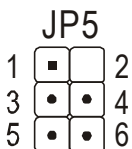

Pin Assignments:

1 = NC	2 = KEY
3 = VCC	4 = Ground
5 = IrTx	6 = IrRx

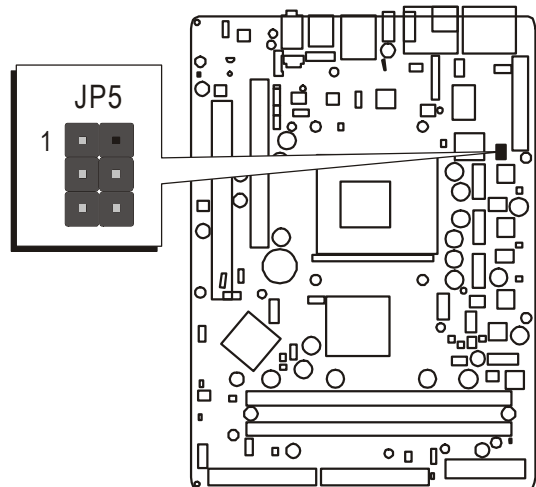

Ⓔ Extended Parallel Port Header (JP12)

One parallel port header is located at the rear panel of the mainboard.
The header is used to connect the cable attached to a parallel connector.
But the parallel cable and connector are optional at the time of purchase.

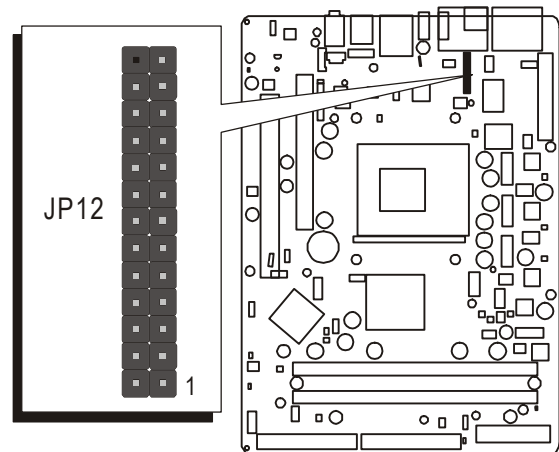
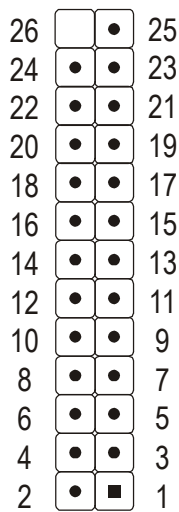

Pins Assignment:

1 = PSTB	8 = PPPD6	15 = P_-ERR	22 = GND
2 = PPPD0	9 = PPPD7	16 = PINIT	23 = GND
3 = PPPD1	10 = P_-ACK	17 = PSLCTIN	24 = GND
4 = PPPD2	11 = P_-BUSY	18 = GND	25 = GND
5 = PPPD3	12 = P_-PE	19 = GND	26 = KEY
6 = PPPD4	13 = P_-SLCT	20 = GND	
7 = PPPD5	14 = PAUTOFD	21 = GND	

E7 AGP Protection LED (D16)

The mainboard provides one 1.5V AGP card which supports up to 8X. If you plug the 3V AGP card on the mainboard, the AGP Protection LED will flash and you can't turn on the computer.

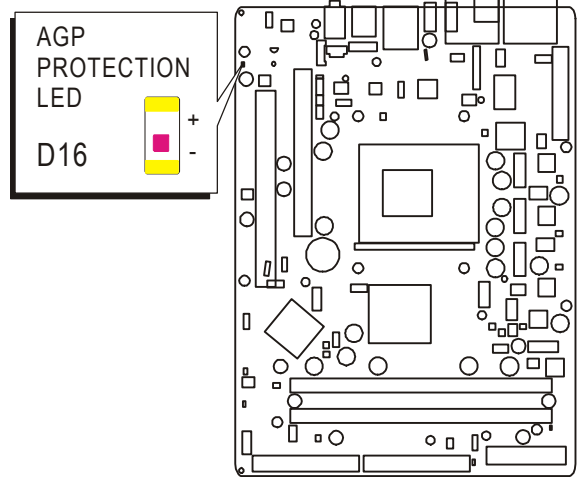

E8 CPU Overtemperature LED (D14)

When CPU temperature over 85°C, the system will cut off the power supply directly, and the CPU Overtemperature LED will flash. You must remove AC Power and check the CPU and heatsink are securely fastened well.

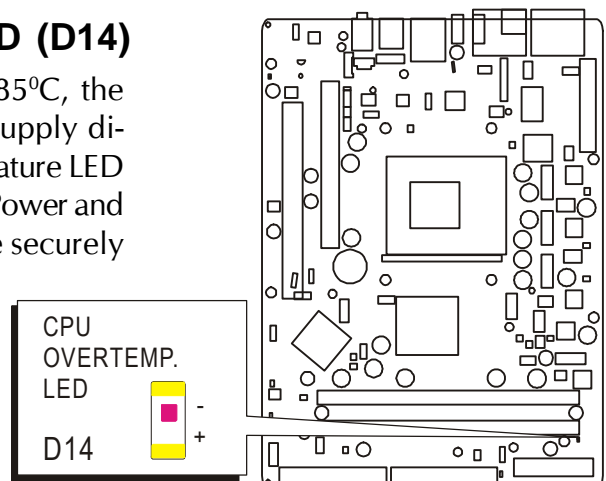

3.3 System Memory Configuration

The FN41V3 mainboard has two 184-pin DIMM slots that allow you to install from 64MB up to 2GB of system memory. Each 184-pin DIMM (Dual In-line Memory Module) slot can accommodate 64MB, 128MB, 256MB, 512MB, and 1GB of PC1600/PC2100/PC2700/PC3200 compliant 2.5V single or double side 64-bit wide data path DDR SDRAM modules. You do not need to set any jumper to configure memory since the BIOS utility can detect the system memory automatically. You can check the total system memory value in the BIOS Standard CMOS Setup menu.

1. Install Memory:

Install memory in any or all of the banks. The combination shown as follows.

DIMM Socket	Memory Modules	Module Quantity
DIMM 1	64MB, 128MB, 256MB, 512MB and 1GB184-pin 2.5V DDR SDRAM DIMM	x 1
DIMM 2	64MB, 128MB, 256MB, 512MB and 1GB184-pin 2.5V DDR SDRAM DIMM	x 1

Note: The total installed memory does not exceed 2GB.

Note: Installing a DIMM in any slot leads to a 64-bit data transfer rate. To activate a dual-channel feature of a 128-bit data transfer rate, install DIMMs in both slots.

2. Upgrade Memory:

You can easily upgrade the system memory by inserting additional DDR SDRAM modules in available DIMM banks. The total system memory is calculated by simply adding up the memory in all DIMM banks. After upgrade, the new system memory value will automatically be computed and displayed in the field "Standard CMOS Setup" of BIOS setup program.

4 SOFTWARE UTILITY

4.1 Mainboard CD Overview

Note: The CD contents attached in FN41V3 mainboard are subject to change without notice.

To start your mainboard CD disc, just insert it into your CD-ROM drive and the CD AutoRun screen should appear. If the AutoRun screen does not appear, double click or run D:\Autorun.exe (assuming that your CD-ROM drive is drive D:)

Navigation Bar Description:

- ☞ Install Mainboard Driver- Installing NVIDIA Chipset Driver
- ☞ Manual - FN41V3 Series mainboard user's manual in PDF format.
- ☞ Link to Shuttle Homepage - Link to shuttle website homepage.
- ☞ Browse this CD - Allows you to see contents of this CD.
- ☞ Quit - Close this CD.



4.2 Install Mainboard Software

Insert the attached CD into your CD-ROM drive and the CD AutoRun screen should appear. If the AutoRun screen does not appear, double click on Autorun icon in My Computer to bring up Shuttle Mainboard Software Setup screen.

Select using your pointing device (e.g. mouse) on the “Install Mainboard Driver” bar to install Mainboard Software.

The Mainboard FN41V3 Softwaree include:

- [4.2.A] Install NVIDIA Chipset Driver
- [4.2.B] Install VGA Device Driver



4.2A Install NVIDIA Chipset Driver

Insert the attached CD into your CD-ROM drive and the CD AutoRun screen should appear. If the AutoRun screen does not appear, double click on Autorun icon in My Computer to bring up Shuttle Mainboard Software Setup screen.

Select using your pointing device (e.g. mouse) on the "Install NVIDIA Chipset Driver" bar to install NVIDIA chipset driver.



Once you made your selection, a Setup window run the installation automatically.

When the copying files is done, make sure you reboot the system to take the installation effect.

4.2B Install VGA Device Driver

Insert the attached CD into your CD-ROM drive and the CD AutoRun screen should appear. If the AutoRun screen does not appear, double click on Autorun icon in My Computer to bring up Shuttle Mainboard Software Setup screen.

Select using your pointing device (e.g. mouse) on the "Install VGA Device Driver" bar to install NVIDIA chipset driver.



Once you made your selection, a Setup window run the installation automatically.

When the copying files is done, make sure you reboot the system to take the installation effect.

4.3 View the User's Manual

Insert the attached CD into your CD-ROM drive and the CD AutoRun screen should appear. If the AutoRun screen does not appear, double click on AutoRun icon in My Computer to bring up Shuttle Mainboard Software Setup screen.

Select using your pointing device (e.g. mouse) on the " Manual " bar.



Then Online Information windows will appear on your screen. Click on the " Install Acrobat Reader " bar if you need to install acrobat reader.



Then click on "FN41v3 Manual" bar to view user's manual.

5 BIOS SETUP

FN41V3 BIOS ROM has a built-in Setup program that allows users to modify the basic system configuration. This information is stored in battery-backed RAM so that it retains the Setup information even if the system power is turned off.

The system BIOS is managing and executing a variety of hardware related functions in the system, including:

- System date and time
- Hardware execution sequence
- Power management functions
- Allocation of system resources

5.1 Enter BIOS

To enter the BIOS (Basic Input /Output System) utility, follow these steps:

- Step 1. Power on the computer, and the system will perform its POST (Power-On Self Test) routine checks.
- Step 2. Press key immediately, or at the following message:
Press DEL to enter SETUP, or simultaneously press <Ctrl>, <Alt>, <Esc> keys.

Note1. If you miss trains of words mentioned in step2 (the message disappears before you can respond) and you still wish to enter BIOS Setup, restart the system and try again by turning the computer OFF and ON again or by pressing the <RESET> switch located at the computer front-panel. You may also reboot by simultaneously pressing the <Ctrl>, <Alt>, keys.

Note2. If you do not press the keys in time and system does not boot, the screen will prompt an error message, and you will be given the following options:

"Press F1 to Continue, DEL to Enter Setup"

- Step 3. As you enter the BIOS program, CMOS Setup Utility will prompt you the Main Menu, as shown in the next section.

5.2 The Main Menu

Once you enter the Award BIOS(tm) CMOS Setup Utility, the Main Menu will appear on the screen. The Main Menu allows you to select from several setup functions and two exit choices. Use the arrow keys to select among the items and press <Enter> to accept and enter the sub-menu.

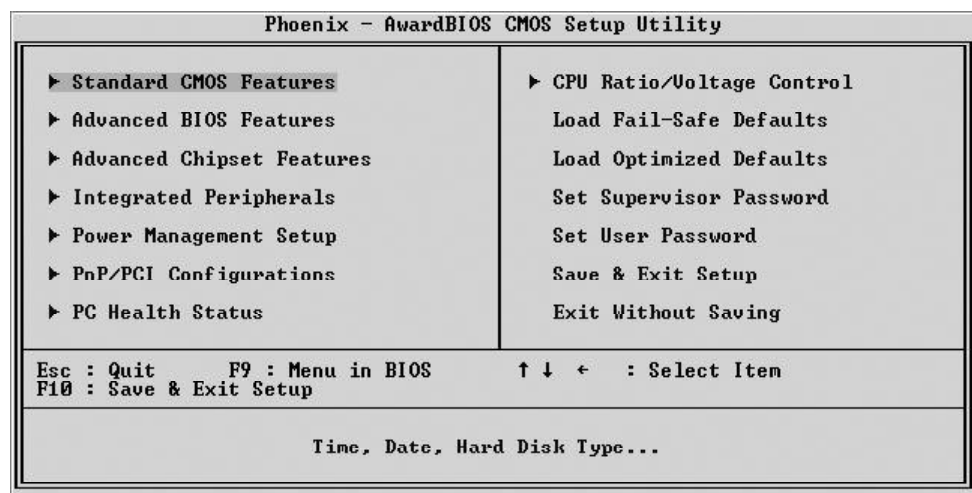

Note that a brief description of each highlighted selection appears at the bottom of the screen.

Setup Items

The main menu includes the following main setup categories. Recall that some systems may not include all entries.

Standard CMOS Features

This menu displays the basic information about your system.

Advanced BIOS Features

Use this menu to set the advanced features available on your system.

Advanced Chipset Features

Use this menu to change the values in the chipset registers and optimize your system's performance.

Integrated Peripherals

Use this menu to specify your settings for integrated peripherals.

Power Management Setup

Use this menu to specify your settings for power management.

PnP/PCI Configurations

This option configures how PnP (Plug and Play) and PCI expansion cards operate in your system.

PC Health Status

This entry shows the current system temperature, voltage, and fan speed.

CPU Ratio/Voltage Control

Use this menu to specify your settings for the ratio/voltage control.

Load Fail-Safe Defaults

Use this menu to install fail-safe defaults for all appropriate items in the setup utility.

Load Optimized Defaults

Use this menu to install optimized defaults for all appropriate items in the setup utility.

Set Supervisor/User Password

Use this menu to change, set, or disable supervisor/user password. It allows you to limit access to the system and Setup, or only to Setup.

Save & Exit Setup

Save the changes that you have made in the Setup Utility and exit the Setup Utility.

Exit Without Saving

Abandon all changes that you have made in the Setup Utility and exit the Setup Utility.



Standard CMOS Features

Use the arrow keys to highlight the item and then use the <PgUp> or <PgDn> keys to select the value you want in each item.

Phoenix - AwardBIOS CMOS Setup Utility Standard CMOS Features		
Date <mm:dd:yy> Time <hh:mm:ss>	Tue, Jan 6 2004 23 : 36 : 3	Item Help
▶ IDE Primary Master	[None]	Menu Level ▶
▶ IDE Primary Slave		Change the day, month, year and century.
▶ IDE Secondary Master		
▶ IDE Secondary Slave	[None]	
Drive A	[1.44M, 3.5 in.]	
Drive B	[None]	
Video	[EGA/VGA]	
Halt On	[All , But Keyboard]	
Base Memory	640K	
Extended Memory	64512K	
Total Memory	65536K	
↑↓:Move Enter:Select +/-/PU/PD:Uvalue F10:Save ESC:Exit F1:General Help F5: Previous Values F6: Fail-Safe Defaults F7: Optimized Defaults		

Date (mm : dd : yy)

Set the system date. Note that if you are running a Windows OS, this items are automatically updated whenever you make changes to the Windows Date.

Time (hh : mm : ss)

Set the system time. The time is converted based on the 24-hour military-time clock. For example, 5:00:00 p.m. is 17:00:00.

IDE Primary/Secondary Master/Slave

Press <Enter> to enter the sub-menu of detailed options.

Drive A/DriveB

Select the type of floppy disk drive installed in your system.

- ▶ The choice: None, 360K, 5.25 in, 1.2M, 5.25 in, 720K, 3.5 in, 1.44M, 3.5 in, or 2.88M, 3.5 in.

Video

This item defines the video mode of the system. Leave this item at the default value.

- ▶ The choice: EGA/VGA, CGA 40, CGA 80, or MONO.

Halt On

This item defines the operation of the system POST (Power-On Self Test) routine. You can use this item to select which situation you want the BIOS to stop the POST process and notify you.

- ▶ The choice: All Errors, No Errors, All, But Keyboard, All, But Diskette, or All, But Disk/Key.

Base Memory/Extended Memory/Total Memory

These items are automatically detected by the system at start up time.
These are display-only fields. You can't make change to these fields.

IDE Adapters

The IDE adapters control the hard disk drive. Use a separate sub-menu to configure each hard disk drive.

IDE HDD Auto-Detection

Press <Enter> to auto-detect HDD on this channel. If detection is successful, it fills the remaining fields on this menu.

IDE Primary Master

Selecting 'Manual' lets you set the remaining fields on this screen and select the type of fixed disk.

- The choice: None, Auto, or Manual.

Access Mode

Choose the access mode for this hard disk.

- The choice: CHS, LBA, Large, or Auto.

Capacity

Note that the disk drive capacity (approx.) is usually slightly greater than the size of a formatted disk given by a disk checking program.

The following options are selectable only if the 'IDE Primary Master' item is set to 'Manual', and the 'Access Mode' item is set to 'CHS'.

Cylinder

Set the number of cylinders for this hard disk.

- Min = 0, Max = 65535

Head

Set the number of read/write heads.

- Min = 0, Max = 255

Precomp

Warning: Setting a value of 65535 means no hard disk.

- Min = 0, Max = 65535

Landing Zone

Set the Landing Zone size.

- Min = 0, Max = 65535

Sector

Number of sector per track.

- Min = 0, Max = 255

Advanced BIOS Features

This section allows you to configure your system for basic operation.

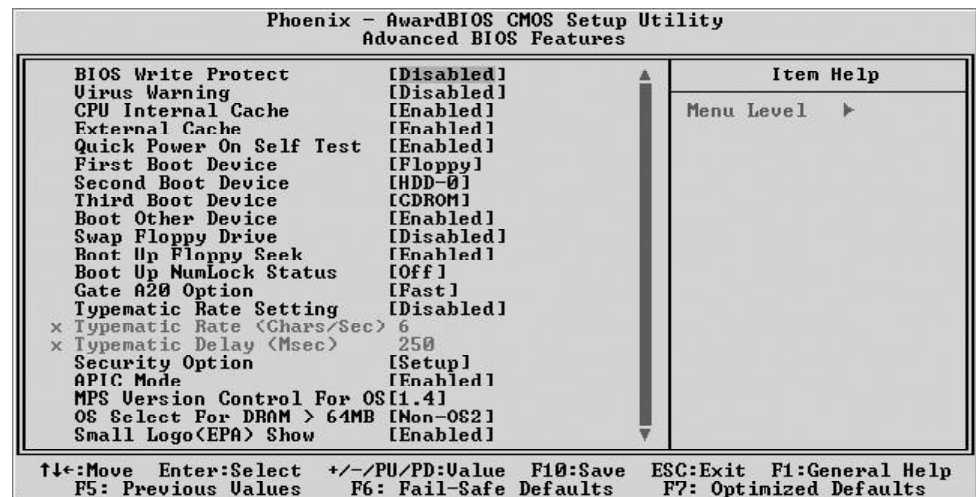

BIOS Write Protect

This item let you enable or disable the BIOS Write Protect.

- The choice: Enabled or Disabled.

Virus Warning

Allows you to choose the VIRUS Warning feature for IDE Hard Disk boot sector protection. Enable this item to prevent someone from writing data into this area.

Enabled Activates automatically when the system boots up, causing a warning message to appear when anything attempts to access the boot sector or hard disk partition table.

Disabled No warning message will appear when anything attempts to access the boot sector or hard disk partition table.

- The choice: Enabled or Disabled.

CPU Internal Cache

All processors that can be installed in this mainboard use internal level 1 (L1) cache memory to improve performance. Leave this item at the default value for better performance.

- The choice: Enabled or Disabled.

External Cache

Most processors that can be installed in this system use external level 2 (L2) cache memory to improve performance. Leave this item at the default value for better performance.

- The choice: Enabled or Disabled.

Quick Power On Self Test

Enable this item to shorten the power on testing (POST) and have your system start up faster. You might like to this item after you are confident that your system hardware is operating smoothly.

- The choice: Enabled or Disabled.

First/Second/Third Boot Device

Use these three items to select the priority and order of the devices that your system searches for an operating system at start-up time.

- The Choice: Floppy, LS120, HDD-0, SCSI, CDROM, HDD-1, HDD-2, HDD-3, ZIP100, USB-FDD, USB-ZIP, USB-CDROM, USB-HDD, LAN, or Disabled.

Boot Other Device

If you enable this item, the system searches all other possible locations for and operating system if it fails to find one in the devices specified under the First, Second, and Third boot devices.

- The choice: Enabled or Disabled.

Swap Floppy Drive

If you have two floppy diskette drives in your system, this item allows you to swap the assigned drive letters so that drive A becomes drive B, and drive B becomes drive A.

- The choice: Enabled or Disabled.

Boot Up Floppy Seek

If this item is enabled, it checks the size of the floppy disk drives at start-up time. You don't need to enable this item unless you have a legacy diskette drive with 360k capacity.

- The choice: Enabled or Disabled.

Boot Up NumLock Status

This item defines if the keyboard Num Lock key is active when your system is started.

- The choice: Off or On.

Gate A20 Option

This item defines how the system handles legacy software that was written for an earlier generation of processors. Leave this item at the default value.

- The choice: Normal or Fast.

Typematic Rate Setting

If this item is enabled, you can use the following two items to see the typematic rate and the typematic delay settings for your keyboard.

- The choice: Enabled or Disabled.

Typematic Rate (Chars/Sec)

This item sets how many times the keystroke will be repeated in a second when you hold a key down.

- The choice: 6, 8, 10, 12, 15, 20, 24, or 30.

Typematic Delay (Msec)

Sets the delay time after a key is held down.

- The choice: 250, 500, 750, or 1000.

Security Option

If you have installed password protection, this item defines if the password is required at system start up, or if it is only required with a user tries to enter the Setup Utility.

- The choice: Setup or System.

APIC Mode

This option is used to enable or disable APIC (Advanced Programmable Interrupt Controller) functionality.

- The choice: Enabled or Disabled.

MPS Version Control For OS

Selects the operating system multiprocessor support version.

- The choice: 1.1 or 1.4

OS Select For DRAM > 64MB

This item is only required if you have installed more than 64 MB of memory and you are running the OS/2 operating system. Otherwise, leave this item at the default.

- The choice: Non-OS2 or OS2.

Small Logo(EPA) Show

This item allows you to enable or disable the EPA Logo.

- The choice: Enabled or Disabled.



Advanced Chipset Features

These items define critical timing parameters of the mainboard. You should leave the items at their default values unless you are very familiar with the technical specifications of your system hardware. If you change the values incorrectly, you may introduce fatal errors or recurring instability into your system.

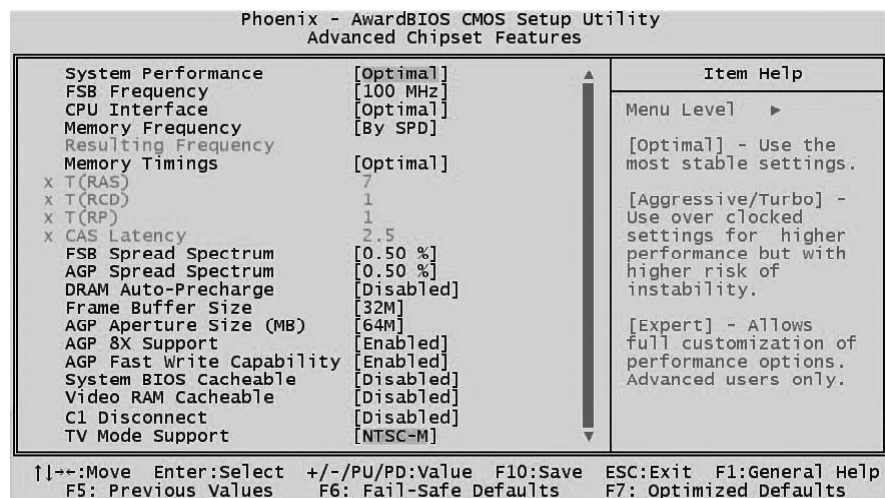

System Performance

[Optimal] - Use the most stable settings.

[Aggressive/Turbo] - Use over clocked settings for higher performance but with higher risk of instability.

[Expert] - Allows full customization of performance options. Advanced users only.

➤ The choice: Optimal, Aggressive, Turbo, or Expert.

FSB Frequency

This item select FSB frequency.

➤ The Choice: 100MHz, 102 ~ 123MHz, 125MHz, 127 ~ 148MHz, 150MHz, 152 ~ 175MHz, 177 ~ 200MHz, 202 ~ 211MHz, 213 ~ 223MHz, 225MHz, 227 ~ 250MHz.

CPU Interface

[Optimal] - Use most stable CPU/FSB parameters.

[Aggressive] - Use over clocked CPU/FSB parameters.

➤ The choice: Optimal or Aggressive.

Memory Frequency

This item select DDR SDRAM frequency.

➤ The choice: By SPD, 50%, 60%, 66%, 75%, 80%, 83%, 100%, 120%, 125%, 133%, 150%, 166%, 200%, or Auto.

Resulting Frequency

This item presents the DDR SDRAM frequency you've selected in the previous item.

Memory Timings

This item allows you to set the Memory Timings. The following four items become available as this item is set to Expert.

- The choice: Optimal, Aggressive, Turbo, or Expert.

T(RAS)

This item defines the timing delay for DRAM precharge.

- The choice: 1 ~ 15.

T(RCD)

This item defines the timing of the transition from RAS (row address strobe) to CAS (column address strobe) as both rows and columns are separately addressed shortly after DRAM is refreshed.

- The choice: 1 ~ 7.

T(RP)

This item defines the numbers of cycles for RAS to be allowed to precharge.

- The choice: 1 ~ 7.

CAS Latency

This item defines the timing delay in clock cycles before SDRAM starts a read command after receiving it.

- The choice: 2.0, 2.5, or 3.0.

FSB Spread Spectrum

This item allows you to set the spread spectrum modulation.

- The choice: Disabled, 0.50%, or 1.00%.

AGP Spread Spectrum

This item allows you to set the spread spectrum modulation.

- The choice: Disabled or 0.50%.

DRAM Auto-Precharge

If Auto-Precharge is enabled, the row being accessed will be precharged at the end of the WRITE burst; If Auto-Precharge is disabled, the row will remain open for subsequent accesses.

- The choice: Disabled, or Enabled.

Frame Buffer Size

This item specifies the shared memory size.

- The choice: Disabled, 8M, 16M, 32M, 64M or 128M.

AGP Aperture Size (MB)

Select the size of Accelerated Graphics Port (AGP) aperture. The aperture is a portion of the PCI memory address range dedicated to graphics memory address space. Host cycles that hit the aperture range are forwarded to the AGP without any translation.

- The choice: 32M, 64M, 128M, 256M, or 512M.

AGP 8X Support

This item allows you to enable or disable AGP 8X Support.

- The choice: Enabled or Disabled.

AGP Fast Write Capability

This item enables an end user to manually select the AGP output buffer driver strength.

- The Choice: Enabled or Disabled.

System BIOS Cacheable

Select Enabled allows caching of the system BIOS ROM at F000h-FFFFh, resulting in better system performance. However, if any program is written to this memory area, a system error may result.

- The Choice: Enabled or Disabled.

Video RAM Cacheable

Select Enabled allows caching of the video BIOS, resulting in better system performance. However, if any program is written to this memory area, a system error may result.

- The Choice: Enabled or Disabled.

C1 Disconnect

Force En/Disabled or Auto Mode: C17 IGP/SPP NB A03 C18D SPP NB A01(C01) enabled C1 Disconnect otherwise disabled it

- The Choice: Enabled or Auto.

TV Mode Support

This item specifies a type for the TV.

- The choice: NTSC_M, NTSC_J, PAL_M, PAL_BDGH, PAL_N, PAL_NC

Integrated Peripherals

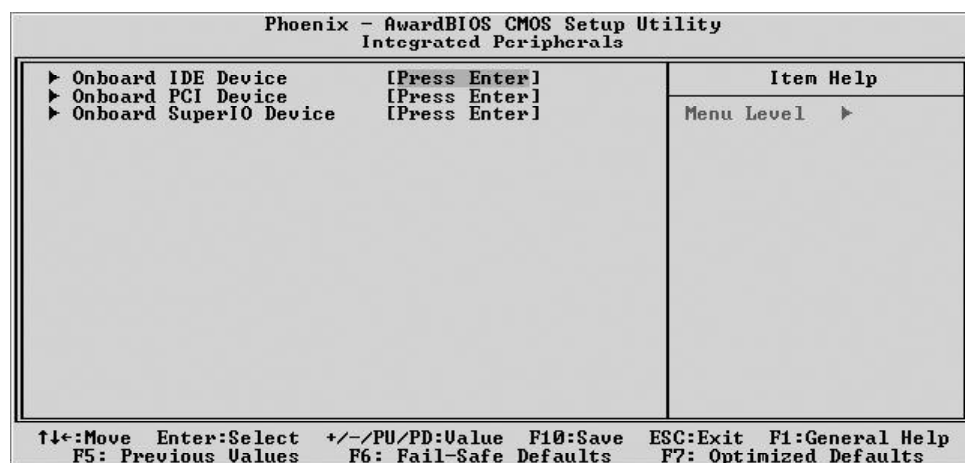

Onboard IDE Device

Press <Enter> to enter the sub-menu of detailed options.

OnChip IDE Channel0/Channel1

The chipset contains a PCI IDE interface with support to two IDE channels. Select Enabled to activate the primary/secondary IDE interface. select Disabled to deactivate the primary/secondary interface.

➤ The Choice: Enabled or Disabled.

Primary/Secondary Master/Slave PIO

The four IDE PIO (Programmed Input/Output) fields let you set a PIO mode (0-4) for each of the four IDE devices that the onboard IDE interface supports. Modes 0 through 4 provide successively increased performance. In Auto mode, the system automatically determines the best mode for each device.

➤ The choice: Auto, Mode 0, Mode 1, Mode 2, Mode 3, or Mode 4.

Primary/Secondary Master/Slave UDMA

Ultra DMA implementation is possible only if your IDE hard drive supports it and the operating environment includes a DMA driver (Windows 95 OSR2 or a third-party IDE bus master driver). If both of your hard drive and your system software support Ultra DMA, select Auto to enable BIOS support.

➤ The choice: Auto or Disabled.

IDE Prefetch Mode

The onboard IDE drive interface support IDE prefetching for faster drive access. If you install a primary and/or secondary add-on IDE interface, set this field to Disabled if the interface does not support prefetching.

➤ The Choice: Enabled or Disabled.

IDE DMA transfer access

This item allows you to enable or disable IDE DMA transfer access.

➤ The Choice: Enabled or Disabled.

IDE HDD Block Mode

Block mode is also called block transfer, multiple commands, or multiple sector read/write. If your IDE hard drive supports block mode (most new drives do), select Enabled for automatic detection of the optimal number of block read/write per sector the drive can support.

➤ The Choice: Enabled or Disabled.

Onboard PCI Device

Press <Enter> to enter the sub-menu of detailed options.

Init Display First

This item is used to determine initial device when system power on.

➤ The choice: PCI Slot or Onboard/AGP.

OnChip USB

Do not disable this item if your system has a USB installed on the system board and you want to use it.

➤ The choice: Disabled, V1.1 + V2.0, or V1.1.

USB Keyboard Support

Select Enabled if your system contains a Universal Serial Bus (USB) controller and you have a USB keyboard.

➤ The Choice: Enabled or Disabled.

OnChip Audio

This item allows you to control the OnChip Audio.

➤ The Choice: Auto or Disabled.

OnChip Lan

This item allows you to set the OnChip Lan.

➤ The Choice: Auto or Disabled.

OnChip 1394

This item allows you to set the OnChip 1394.

➤ The Choice: Auto or Disabled.

Onboard SuperIO Device

Press <Enter> to enter the sub-menu of detailed options.

Onboard FDC Controller

This item specifies onboard floppy disk drive controller. This setting allows you to connect your floppy disk drives to the onboard floppy connector.

- The choice: Enabled or Disabled.

Onboard Serial Port 1

This option is used to assign the I/O address and interrupt request (IRQ) for the onboard serial port 1 (COM1).

- The Choice: Disabled, 3F8-IRQ4, 2F8-IRQ3, 3E8-IRQ4, 2E8-IRQ3, or Auto.

Onboard Infrared Port

This option is used to assign the I/O address and interrupt request (IRQ) for the onboard infrared port.

- The Choice: Disabled, 3F8-IRQ4, 2F8-IRQ3, 3E8-IRQ4, 2E8-IRQ3, or Auto.

UART Mode Select

This item allows you to select an operating mode for the IrDA infrared.

- The choice: IrDA, ASKIR, or SCR.

UR2 Duplex Mode

This item allows you to select the IR half or full duplex function.

- The choice: Full or Half.

Onboard Parallel Port

Allows you to determine an I/O address and interrupt request (IRQ) for the onboard parallel port.

- The choice: 378/IRQ7, 278/IRQ5, 3BC/IRQ7, or Disabled.

Parallel Port Mode

Select an operating mode for the onboard parallel port. Select SPP unless you are certain your system supports other modes.

- The choice: SPP, EPP, ECP, or ECP + EPP.

ECP Mode Use DMA

When the parallel port mode is set to ECP, this item becomes selectable.

- The choice: 1 or 3.



Power Management Setup

The Power Management Setup allows you to configure your system to most effectively saving energy while operating in a manner consistent with your own style of computer use.

Phoenix - AwardBIOS CMOS Setup Utility		Item Help
Power Management Setup		Menu Level ▶
ACPI function	Enabled	
ACPI Suspend Type	[S1<POS>]	
Power Management	[User Define]	
Video Off Method	[DPMS Support]	
HDD Power Down	[Disabled]	
HDD Down In Suspend	[Disabled]	
Soft-Off by PBTN	[Instant-Off]	
WOL<PME#> From Soft-Off	[Disabled]	
WOR<RI#> From Soft-Off	[Disabled]	
USB Resume from S3	[Disabled]	
Power-On by Alarm	[Disabled]	
x Time<dd:hh:mm> of Alarm	? : 0 : 0	
PS2 Keyboard Power ON	[Disabled]	
KB Power ON Password	[Enter]	
Hot Key Power ON	[Any Key]	
PS2 Mouse Power ON	[Disabled]	
PWRON After PWR-Fail	[Off]	

↑↓←:Move Enter:Select +/-/PU/PD:Value F10:Save ESC:Exit F1:General Help
F5: Previous Values F6: Fail-Safe Defaults F7: Optimized Defaults

ACPI Function

This item defines the ACPI (Advanced Configuration and Power Management) feature that makes hardware status information available to the operating system, enables a PC to turn its peripherals on or off for improving the power management, and allows a PC turned on or off by external devices, so that a mouse or keyboard can wake up it.

ACPI Suspend Type

This item allows you to select sleep state when suspend. In the default, S1(POS), the suspend mode is equivalent to a software power down; S3(STR), to the system that shuts down with the exception of a refresh current to the system memory.

- The choice: S1(POS), S3(STR), or S1&S3.

Power Management

This item acts like a master switch for the power-saving modes and hard disk timeouts. If this item is set to Max Saving, power-saving modes occur after a short timeout. If it is set to Min Saving, power-saving modes occur after a longer timeout. If it is set to User Define, you can insert your own timeouts for the power-saving modes.

- The choice: Min Saving, Max Saving, or User Define.

Video Off Method

This determines the manner in which the monitor is blanked.

V/H SYNC + Blank This selection will cause the system to turn off the vertical and horizontal synchronization ports and write blanks to the video buffer.

Blank Screen The item only writes blanks to the video buffer.

DPMS Support Initial display power management signaling.

- The choice: V/H SYNC + Blank, Blank Screen, or DPMS Support.

HDD Power Down

The IDE hard drive will spin down if it is not accessed within a specified length of time. Options are from 1 Min to 15 Min and Disabled.

- The choice: Disabled or 1 Min ~ 15 Min.

HDD Down In Suspend

The item allows you to enable or disable the HDD Down In Suspend.

- The choice: Enabled or Disabled.

Soft-Off By PBTN

Under ACPI you can create a software power down. In a software power down, the system can be resumed by Wake UP Alarms. This item lets you install a software power down that is controlled by the power button on your system. If the item is set to Instant-Off, then the power button causes a software power down. If the item is set to Delay 4 Sec., then you have to hold the power button down for 4 seconds to cause a software power down.

- The choice: Delay 4 Sec. or Instant-Off.

WOL(PME#) From Soft-Off

If this item sets to Enabled, the system power will be turned on when the LAN port receives an incoming signal.

- The choice: Enabled or Disabled.

WOR(RI#) From Soft-Off

If this item is enabled, it allows the system to resume from a software power down or power-saving mode whenever there is an incoming call to an installed fax/modem. You have to connector the fax/modem to the mainboard.

- The choice: Enabled or Disabled.

USB Resume from S3

If you are using USB devices, and the ACPI Suspend Type is set to S3 or S1&S3, enable this item to have USB devices wake up the system from power saving mode.

- The choice: Enabled or Disabled.

Power-On by Alarm

When set to Enabled, the following three fields become available and you can set the date, hour, and minute to turn on your system.

- The choice: Enabled or Disabled.

Time(dd : hh : mm) of Alarm

This item selects the alarm Time.

[dd] ➤ Key in a DEC number: Min = 0, Max = 31.

[hh] ➤ Key in a DEC number: Min = 0, Max = 23.

[mm] ➤ Key in a DEC number: Min = 0, Max = 59.

PS2 Keyboard Power ON

Set a password or a key to awaken the system from a keyboard.

- The choice: Disabled, Password, or Hot KEY.

KB Power ON Password

Press <Enter> to set a password to awaken the system from a keyboard.

Hot Key Power ON

Set a key to awaken the system from a keyboard.

- The choice: Any Key or Ctrl-F1 ~ F12.

PS2 Mouse Power ON

Enable or disable the function of awakening the system from a mouse.

- The choice: Enabled or Disabled.

PWRON After PWR-Fail

This item defines your computer to shut off, automatically restart, or return to its last operating status after power fails.

- The choice: Off, On, or Former-Sts.



PnP/PCI Configurations

This category configures how PnP and PCI operate in your system. Correctly setting up the IRQ and DMA (both PnP and PCI use) assignments will make your system work stably. It is strongly recommended that only technical users make changes to the default settings.

Phoenix - AwardBIOS CMOS Setup Utility	
PnP/PCI Configurations	
Reset Configuration Data	[Disabled]
Resources Controlled By	[Auto<ESCD>]
x IRQ Resources	Press Enter
PCI/VGA Palette Snoop	[Disabled]
	Item Help
	Menu Level ▶
	Default is Disabled. Select Enabled to reset Extended System Configuration Data (ESCD) when you exit Setup if you have installed a new add-on and the system reconfiguration has caused such a serious conflict that the OS cannot boot
↑↓: Move Enter: Select +/-/PU/PD: Value F10: Save ESC: Exit F1: General Help F5: Previous Values F6: Fail-Safe Defaults F7: Optimized Defaults	

Reset Configuration Data

When enabled, any PnP configuration data stored in the BIOS will be cleared from memory, with new data created.

- The choice: Enabled or Disabled.

Resources Controlled By

As stays auto(ESCD), the system will dynamically allocate resources to PnP devices as they are required. As set to manual, the following item become available.

- The choice: Auto(ESCD) or Manual.

IRQ Resources

When the previous item is set to manual, this item allows you respectively assign an interruptive type for IRQ-3, 4, 5, 7, 9, 10, 11, 12, 14, and 15.

- The choice: PCI Device or Reserved.

PCI/VGA Palette Snoop

The item is designed to solve problems caused by some non-standard VGA cards.

- The choice: Enabled or Disabled.



PC Health Status

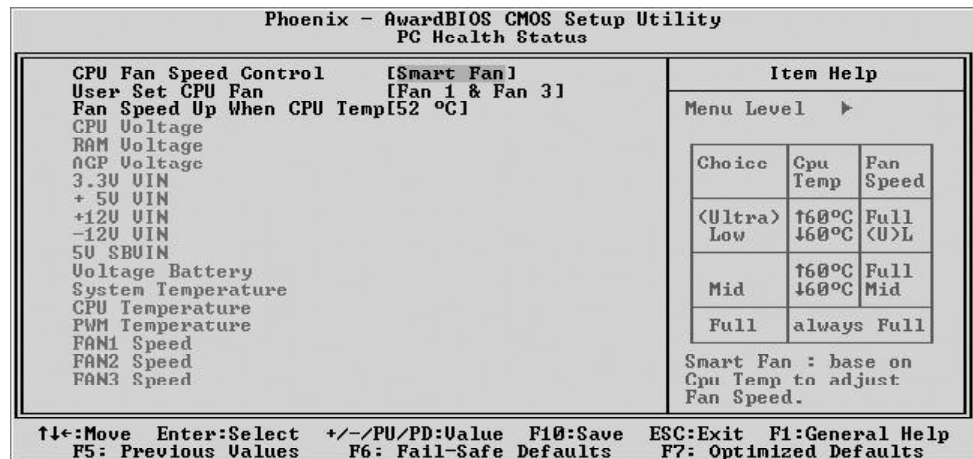

CPU Fan Speed Control

The item defines the fan speed control features.

- The choice: Smart Fan, Ultra-Low, Low, Mid, or Full.

This feature is controlled via BIOS, in which the CPU fan rotational speed sensing/control is governed by CPU temperature setting pre-selected in BIOS. Before manually modifying the CPU fan setting, please make sure both fan connectors are plug into the correct fan connector designations on the mainboard. Our default for fan coolers is set to Fan 1 & Fan 3.

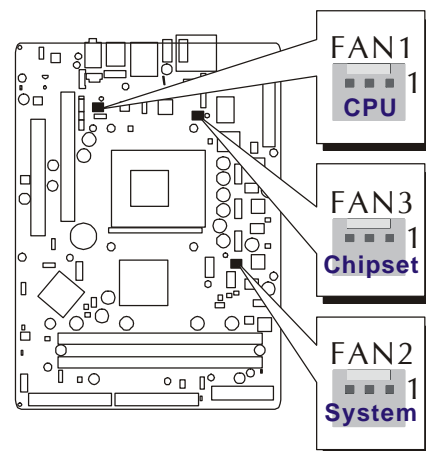

User Set CPU Fan

Enables you to choose one specific fan for further setting.

- The choice: Fan 1, Fan 2, Fan 3, or Fan 1 & Fan 3.

Fan Speed Up When CPU Temp

Enables 3 phase smart controls to the Selected fan. This feature ranges from 40 °C to 52 °C, in an increment of 4 °C.

➤ The choice: 40 °C, 44 °C, 48 °C, or 52 °C.

If actual CPU temp (reported by BIOS) stays below 48 °C then CPU fan speed will run at a quiet mode (1st phase) of approximately 2000 RPM.

But when the actual CPU temp goes above the preselected 48 °C temperature threshold, then CPU fan speed will automatically engage into normal mode (2nd phase) of about 3000 RPM and cool down the CPU temperature. When the CPU temperature drops back below the 48 °C temperature threshold, CPU fan speed will again automatically shift back to the quiet mode (1st phase) to reduce fan noise level.

Fail-safe mode (3rd phase) Variable Fan Speed and CPU temperature Control is as predefined at 52 °C. Where in the event of system and CPU operating under extreme working conditions, and if CPU temperature is raised above 52 °C then the SMART BIOS will engage the CPU fan in Fail-safe mode to rotate at about 3500 RPM. Please note that the higher fan speed, the fan cooler will be become slightly noisier to compensate for the increase in CPU temperature.

The following items provide you with information about the system's current operating status. You cannot make changes to one of them.

CPU Voltage

RAM Voltage

AGP Voltage

3.3V VIN

+5V VIN

+12V VIN

-12V VIN

5V SBVIN

Voltage Battery

System Temperature

CPU Temperature

PWM Temperature

FAN1 Speed

FAN2 Speed

FAN3 Speed

CPU Ratio/Voltage Control

Phoenix - AwardBIOS CMOS Setup Utility		
CPU Ratio/Voltage Control		
CPU Ratio Select	[Auto]	Item Help
CPU Voltage Select	[Auto]	
x CPU Vcore Above 1.85V	1.850 V	Menu Level ▶
RAM Voltage Select	[Auto]	
AGP Voltage Select	[Auto]	

↑↓←:Move Enter:Select +/-/PU/PD:Value F10:Save ESC:Exit F1:General Help
F5: Previous Values F6: Fail-Safe Defaults F7: Optimized Defaults

CPU Ratio Select

This item allows you to adjust CPU Ratio. The item becomes unavailable if your CPU clock ratio is locked.

- The choice: Auto, X 8.0, X 8.5, X 9.0, X 9.5, X 10.0, X 10.5, X 11.0, X 11.5, X 12.0, X 12.5, X 13.0, X 13.5, X 14.0, X 15.0, X 16.0, X 16.5, X 17.0, X 18.0, X 19.0, X 20.0, X 21.0, X 22.0, or X 23.0.

CPU Voltage Select

This item allows you to adjust CPU Voltage. The following item becomes available when the CPU voltage is set to "Above 1.85V."

- The choice: Auto, Above 1.85V, 1.825 V, 1.800 V, 1.775 V, 1.750 V, 1.725 V, 1.700 V, 1.675 V, 1.650 V, 1.625 V, 1.600 V, 1.575 V, 1.550 V, 1.525 V, 1.500 V, 1.475 V, 1.450 V, 1.425 V, 1.400 V, 1.375 V, 1.350 V, 1.325 V, 1.300 V, 1.275 V, 1.250 V, 1.225 V, 1.200 V, 1.175 V, 1.150 V, 1.125 V, or 1.100 V.

CPU Vcore Above 1.85V

This item allows you to adjust CPU Voltage from 1.850 V to 2.000V.

- The choice: 1.850 V, 1.875 V, 1.900 V, 1.925 V, 1.950 V, 1.975 V, or 2.000 V.

RAM Voltage Select

This item allows you to adjust RAM Voltage.

- The choice: Auto, 2.60 V, or 2.70 V.

AGP Voltage Select

This item allows you to adjust AGP Voltage.

- The choice: Auto, 1.55 V, or 1.60 V.

Load Fail-Safe Defaults

When you press <Enter> on this item, you will get a confirmation dialog box with a message similar to:

Load Fail-Safe Defaults (Y/N) ? N

Pressing 'Y' loads the BIOS default values for the most stable, minimal performance system operations.

Load Optimized Defaults

When you press <Enter> on this item, you will get a confirmation dialog box with a message similar to:

Load Optimized Defaults (Y/N) ? N

Pressing 'Y' loads the default values that are factory-set for optimal performance system operation.

Set Supervisor/User Password

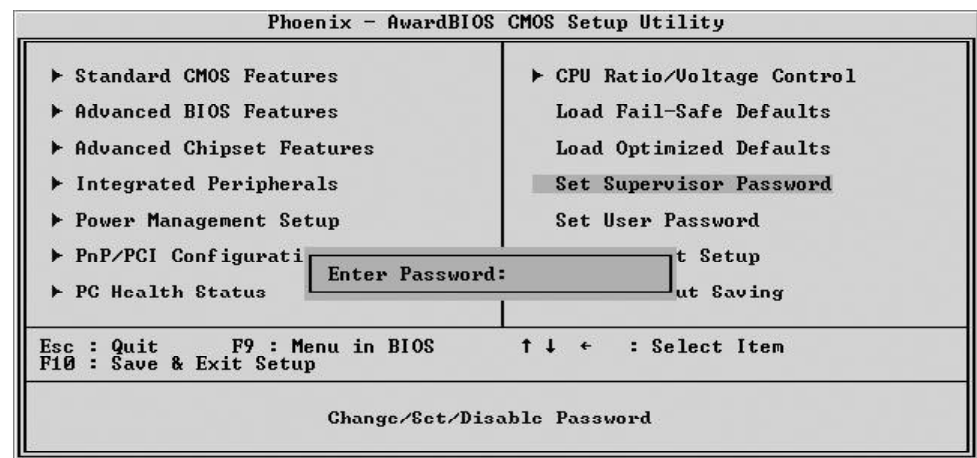

Steps to set supervisor/user password are described as follows:

New Password Setting:

1. While pressing <Enter> to set a password, a dialog box appears to ask you enter a password.
2. Key in a new password. The password can not exceed eight characters.

-
3. System will request you to confirm the new password again.
 4. When completed, new code takes effect.

No Password Setting:

If you want to disable the password, just press <Enter> as a password input is requested.

If You Forget Password:

If you forget the password, the only way to access the system is to clear the CMOS memory. Please refer to page 27 on clear CMOS setting.

 **Save & Exit Setup**

Pressing <Enter> on this item asks for confirmation:

SAVE to CMOS and EXIT (Y/N)? Y

Pressing "Y" stores the selections made in the menus of CMOS - a special section of memory that stays on after you turn your system off. The next time you boot your computer, the BIOS configures your system according to the Setup selections stored in CMOS. After saving the values the system is restarted again.

 **Exit Without Saving**

Pressing <Enter> on this item asks for confirmation:

Quit Without Saving (Y/N)? N

This allows you to exit from Setup without storing in CMOS any change. The previous selections remain in effect. This exits from the Setup utility and restarts your computer.